



KONICA MINOLTA

SPECTROPHOTOMETER CM-2500d

High performance, low cost
portable spectrophotometer.



The essentials of imaging

Designed for versatility in various applications, the CM-2500d is a portable integrating sphere spectrophotometer incorporating Numerical Gloss Control.

Simultaneous measurement of SCI (specular component included) and SCE (specular component excluded). Advanced Numerical Gloss Control.

Simultaneous measurement of SCI and SCE displays the data on the LCD in only 1.5 seconds. Unlike conventional spectrophotometers, there is no need to mechanically switch between SCI and SCE mode. This improves working efficiency and provides stable measured data since the measurement area does not shift when the mode is switched. And also Relativity Gloss Value can be displayed by using Numerical Gloss Control.



For plastics, paints, resins and consumer products

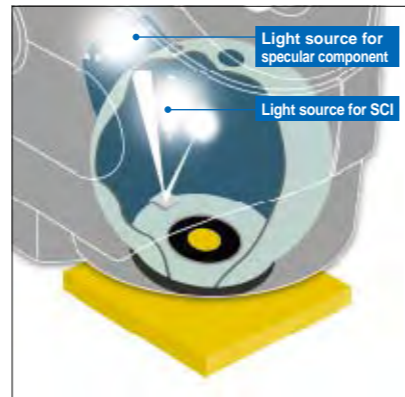

The LCD specifications are subject to change without prior notice.

• SCI is a method in which measurements are taken with the specular reflection included. For this reason, it minimizes influences of the surface condition of a sample, and is especially suitable for color quality control and Computer Color Matching.

• SCE is a method in which measurements are taken excluding the specular reflection. This type of measurement provides results similar to those observed visually.

High reliability and long life. Maintenance-free design.

The number of moving parts in the instrument is minimized through the introduction of numerical control technology. The CM-2500d can be used with confidence, since it has been developed, manufactured and calibrated to meet ISO 9001 requirements.

Allows measurement in any position. Compact, lightweight, with an easy-to-operate navigation wheel and large LCD display.

The battery-powered small, light body allows the instrument to be placed in any position at the sample surface. The CM-2500d's large LCD display and its reverse display function provide easy reading, irrespective of which hand it is held in. Using your finger, the navigation wheel allows simple, user friendly operation.

(Turn) (Push)



For paints, plastics, automobiles, ceramics, architectural interiors, textile, paper, food etc.

Promotes accurate, consistent color communication. Conforms to widely-accepted industry standards and allows measurements in all popular color spaces.

The optics use an integrating sphere to provide diffuse illumination/8-degree viewing system.

The CM-2500d conforms to all widely accepted standards including ISO, JIS, DIN, CIE and ASTM, and generates measurements in color spaces such as L*a*b*, Yxy, Munsell and CMC.

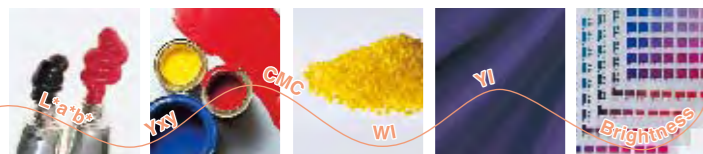

In various applications

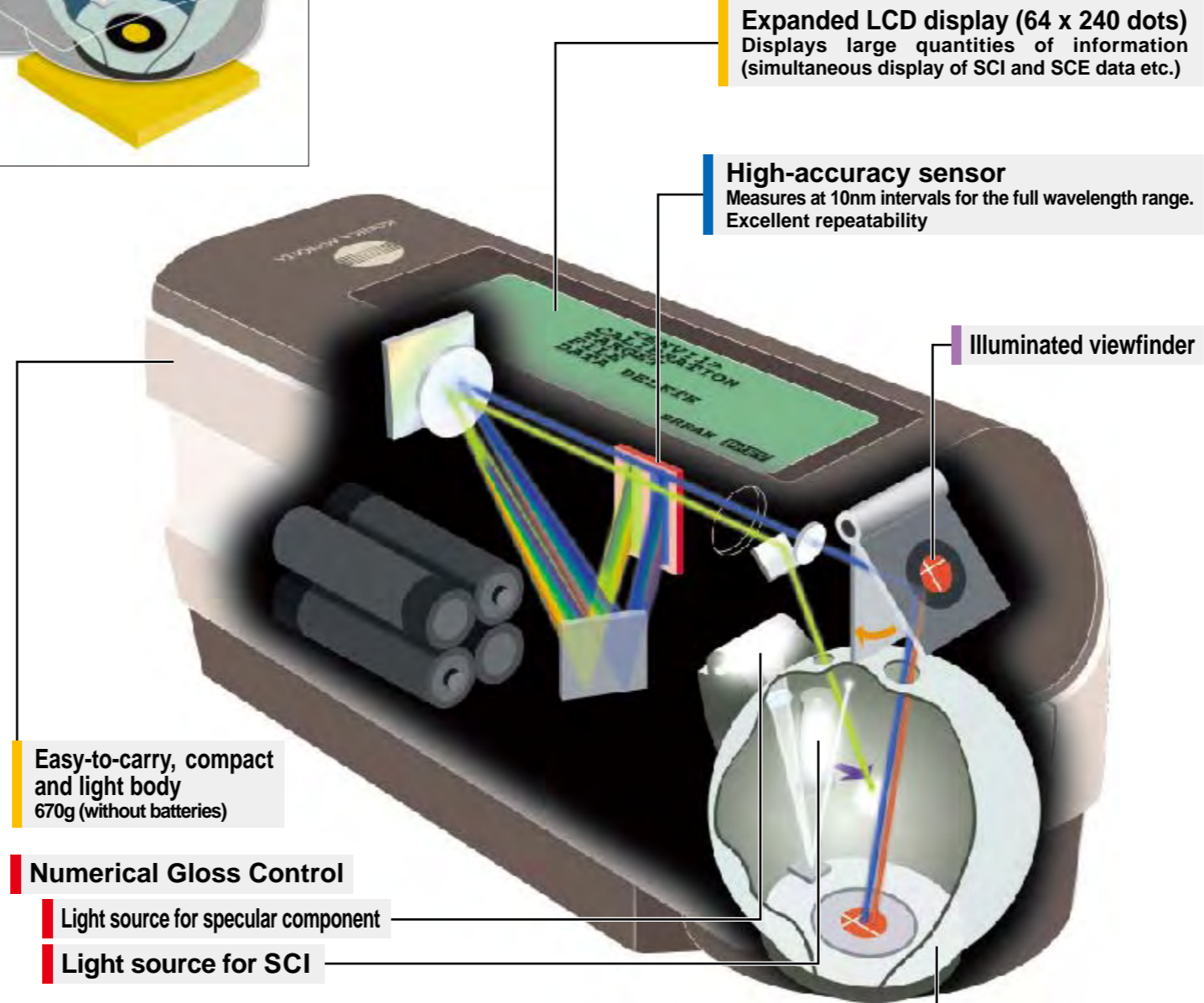

Easy-to-carry, compact and light body 670g (without batteries)

Numerical Gloss Control

Light source for specular component

Light source for SCI

Measures the target with high accuracy. Easy-to-carry stylish body with an illuminated viewfinder.

The user can choose the most suitable measurement area for the target. The easy-to-carry body with the illuminated viewfinder enables the user to position the instrument on the target quickly and accurately.



For pharmaceuticals, cosmetics, printing, building materials, textiles, food etc.

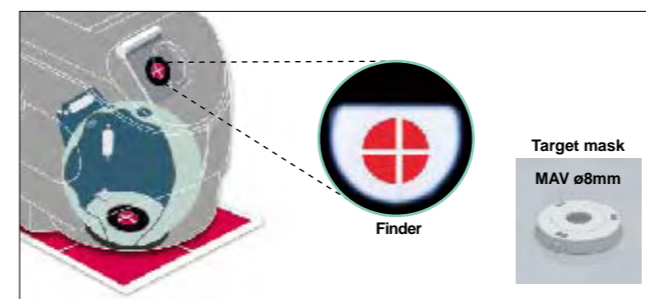

Powerful partnership between CM-2500d and SpectraMagic™ NX

Color Data Software

SpectraMagic™ NX (Optional)

Supports Windows®2000/XP/Vista

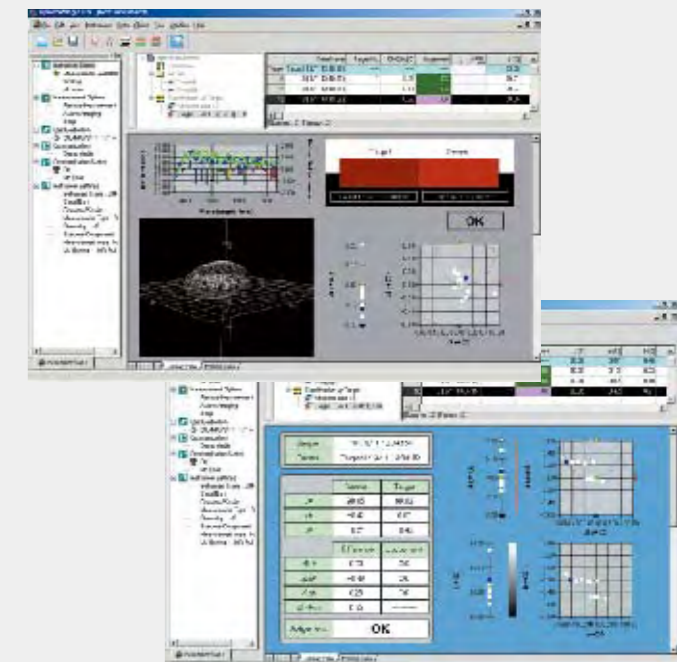
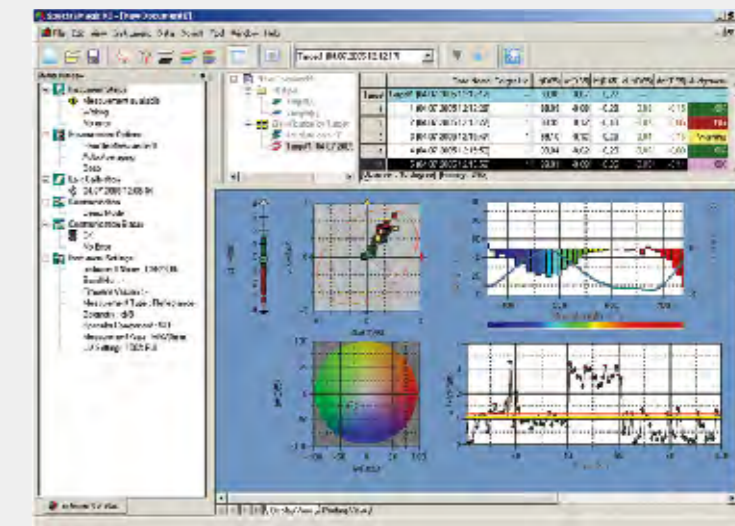

SpectraMagic™ NX enables you to perform comprehensive color inspection and analysis of incoming raw materials, in process production, and outbound color critical goods and materials in virtually any industry. With SpectraMagic™ NX you can insert digital images with measured data. Measure samples in any of 8 universally accepted color spaces. Select from 15 illuminants, and up to 40 indices to determine specific color and appearance properties, such as strength, brightness, haze, yellowness, opacity and strength. You can even configure up to 3 customized color equations. Reports range from simple Pass/Fail to trend charts, histograms, color plots, and spectral graphs. SpectraMagic™ NX comes with predefined templates using skin technology, or you can create your own templates. For illustrations and explanations to understanding color and color measurement technology, there is a link to Konica Minolta's well known and respected "Precise Color Communication". Step by step navigation help.

• Windows® is a trademark of Microsoft Corporation in the USA and other countries.

Specifications	
Illumination/viewing system	di:8°, de:8° (diffuse illumination, 8-degree viewing), equipped with simultaneous measurement of SCI (specular component included) /SCE (specular component excluded) Conforms to CIE No.15,ISO 7724/1, ASTM E1164, DIN 5033 Teil7 and JIS Z8722 Condition C standard.
Sphere Size	ø52mm
Light-receiving element	Silicon photodiode array (dual 40 elements)
Spectral separation device	Diffraction grating
Wavelength range	360nm to 740nm
Wavelength pitch	10nm
Half bandwidth	Approx. 10nm
Reflectance range	0 to 175%, resolution: 0.01%
Light source	2 pulsed xenon lamps
Measurement time	Approx. 1.5 seconds (approx. 2 seconds for fluorescent measurement)
Minimum interval between measurements	3 seconds for SCI/SCE (4 seconds for fluorescent measurement)
Battery performance	Alkaline manganese: approx. 1000 measurements
Measurement/illumination area	MAV: ø8mm/ø11mm
Repeatability	Spectral Reflectance: Standard deviation within 0.1% (360 to 380nm within 0.2%) Colorimetric Value: Standard deviation within ΔE*ab 0.04 (Measurement conditions: White calibration plate measured 30 times at 10-second intervals after white calibration was performed)
Inter instrument agreement	within ΔE*ab 0.2 (MAV/SCI) Average for 12BCRA Series II color tiles compared to values measured with master body.
Measurement mode	Single measurement/automatic averaging of multiple measurements (auto mode: 3, 5, 8 times/manual mode)
Interface	RS-232C standard
Observer	2/10 degrees (CIE 1931/2°, CIE 1964/10°)
Illuminant	A, C, D50, D65, F2, F6, F7, F8, F10, F11, F12 (simultaneous evaluation is possible using two light sources)
Display data	Spectral value/graph, colorimetric value, color difference value/graph, PASS/FAIL result
Color space/colorimetric data	L*a*b*, L*C*h, CMC (1:1), CMC (2:1), CIE94, Hunter Lab, Yxy, Munsell, XYZ, MI, WI (ASTM E313), YI (ASTM E313/ASTM D1925), ISO Brightness (ISO 2470), Density status A/T, WI/Tint (CIE/Ganz), CIE00
Data memory	1700 pieces of data (as SCI/SCE 1 data) * 700 pieces of data in the "defined in COND." mode. * Total of the sample data for the COND and TASK modes and color difference target data
Tolerance Display	Tolerance for color difference (both box and elliptical tolerances can be set)
Power source	4 AA-size battery or AC adapter
Size (WxHxD)	69 x 96 x 193mm
Weight	Approx. 670g (without batteries)
Operating temperature/humidity range (*1)	5 to 40°C, relative humidity 80% or less (at 35°C) with no condensation
Storage temperature/humidity range	0 to 45°C, relative humidity 80% or less (at 35°C) with no condensation
Standard accessories	White calibration plate, Target mask ø8mm, RS-232C cable, AC adapter, AA-size battery (x4)
Optional Accessories	Hard case, Dust cover set, Dust cover, SpectraMagic™NX (software), Zero calibration box

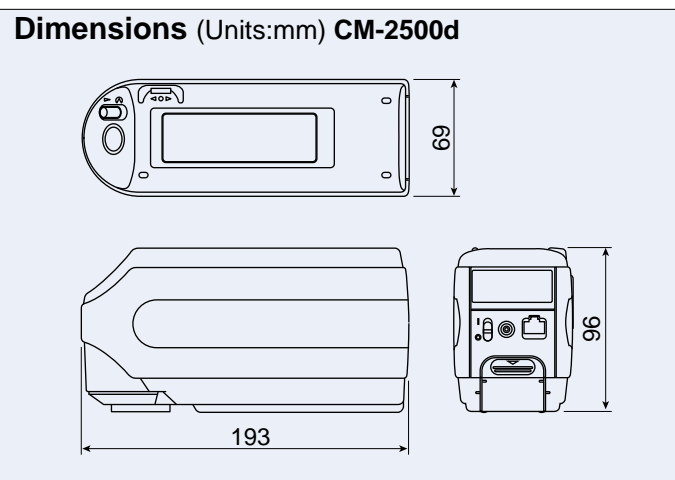
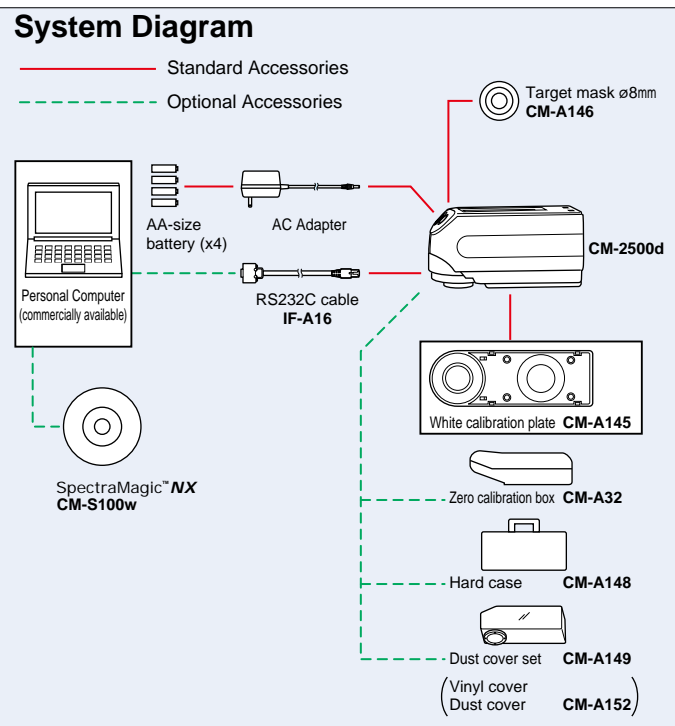

*1 Operating temperature/humidity range of products for North America: 5 to 40°C, relative humidity 80% or less (at 31°C) with no condensation

Color control network by spectrophotometer

High inter-instrument agreement between the portable CM-2500d spectrophotometer and the desktop CM-3000 series make it easy to build a total color control network.

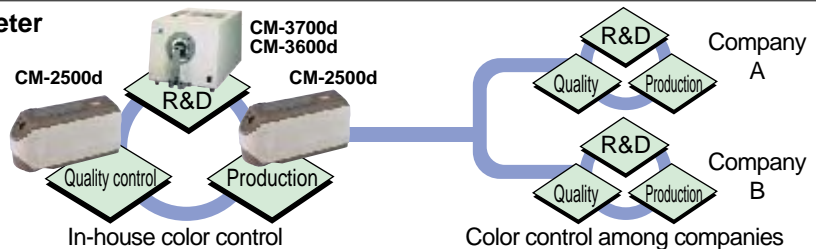

SAFETY PRECAUTIONS

For correct use and for your safety, be sure to read the instruction manual before using the instrument.



- Always connect the instrument to the specified power supply voltage. Improper connection may cause a fire or electric shock.
- Be sure to use the specified batteries. Using improper batteries may cause a fire or electric shock.



Certificate No : YKA 0937154
Registration Date : March 3, 1995



Certificate No : JQA-E-80027
Registration Date : March 12, 1997

* The specifications and drawings given here are subject to change without prior notice.

KONICA MINOLTA SENSING, INC.
Konica Minolta Sensing Americas, Inc.
Konica Minolta Sensing Europe B.V.

Osaka, Japan
New Jersey, U.S.A.
European Headquarter /BENELUX
German Office
French Office
UK Office
Italian Office
Swiss Office
Nordic Office
Austrian Office
Polish Office

Konica Minolta (CHINA) Investment Ltd.
SE Sales Division
SE Beijing Office
SE Guangzhou Office

Konica Minolta Sensing Singapore Pte Ltd.
KONICA MINOLTA SENSING, INC. Seoul Office

Phone : 888-473-2656 (in USA), 201-236-4300 (outside USA)
Nieuwegein, Netherland
München, Germany
Roissy CDG, France
Milton Keynes, United Kingdom
Milan, Italy
Dietikon, Switzerland
Västra Frölunda, Sweden
Wien, Austria
Warszawa, Poland
Shanghai, China
Beijing, China
Guangzhou, China
Singapore
Seoul, Korea

Fax : 201-785-2480
Fax : +31(0)30 248-1280
Fax : +49(0)89 630267-9799
Fax : +33(0)1 493-84771
Fax : +44(0)1908 540-629
Fax : +39(0)23 9011219
Fax : +41(0)43 322-9809
Fax : +46(0)31 474945
Fax : +43(0)1 87882-431
Fax : +48(0)22 56033-01
Fax : +86-021-5489 0202
Fax : +86-010-8522 1241
Fax : +86-020-3826 4223
Fax : +65 6560-9721
Fax : +82(0)2-523-9729

Addresses and telephone/fax numbers are subject to change without notice. For the latest contact information, please refer to the KONICA MINOLTA SENSING Worldwide Offices web page :

<http://konicaminolta.com/instruments/about/network>

PRONOUNCING "SPECTROPHOTOMETER" IS THE ONLY COMPLICATED THING ABOUT OUR LATEST PRODUCT.

We don't need to explain to you how important reliability is in color control issues. Whatever your product is, your customers can count on the same color on every item, and so can you.

Today's spectrophotometers all claim to be highly accurate, lightweight and reliable. So what makes the difference? Whoever uses a spectrophotometer wants to use it intuitively and easily.

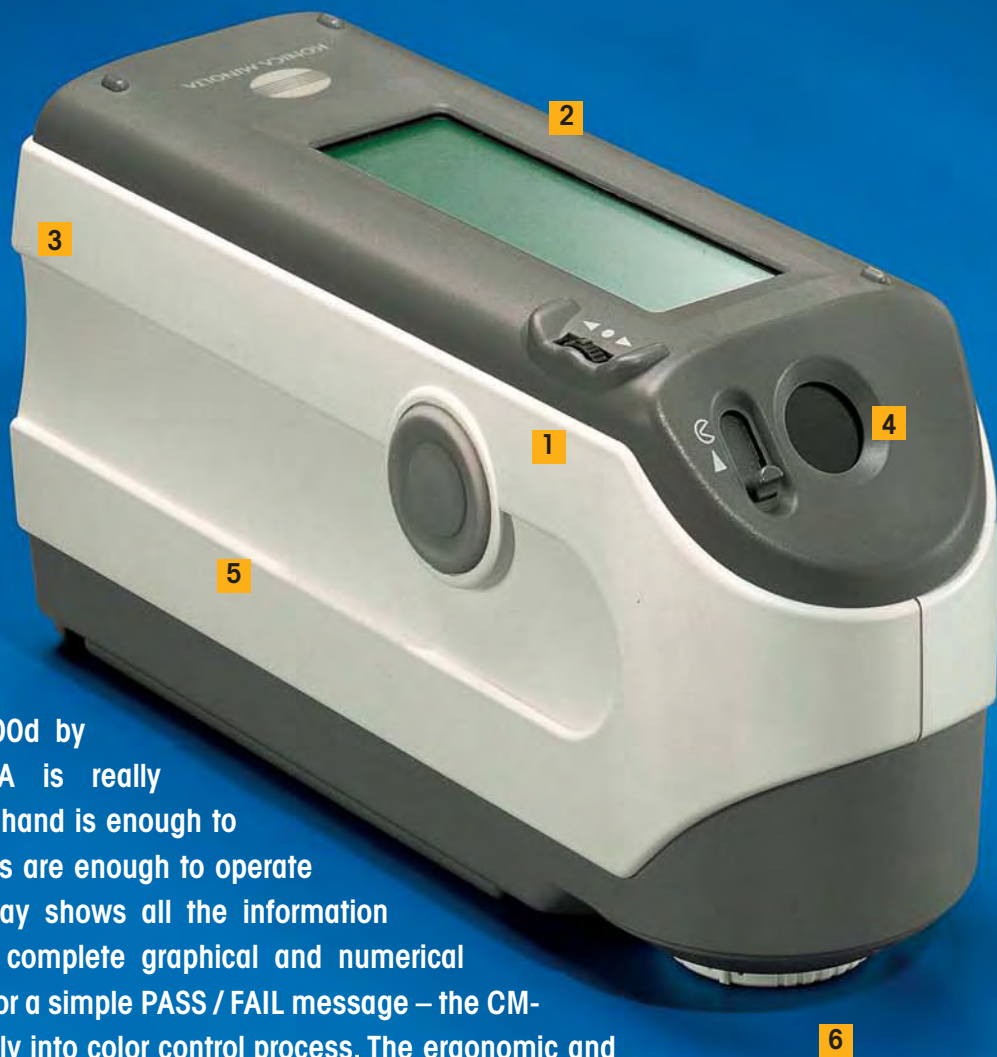

The new CM-2600d by KONICA MINOLTA is really easy to use. One hand is enough to hold it, two fingers are enough to operate it. The large display shows all the information you need, either complete graphical and numerical color information or a simple PASS / FAIL message – the CM-2600d fits perfectly into color control process. The ergonomic and interactive features encompass all applications in color quality control.

1 Single handed operation and you're in control of the all new CM-2600d:

Forget all you have heard about "easy operation" of any portable spectrophotometer so far! The new CM-2600d sets new standards when you look for a simple and fast handling instrument. The exclusive "Navigation wheel" and the measuring button are placed right where your hand fits. The Navigation wheel "guides" you through all the menu options with great ease – Forward, Backward and pressing down like using a PC mouse.



4 What you see is what you get:

Sample observation for precise targeting of small specimens has never been as simple as with the CM-2600d. Forget about these fuzzy "stapler" type targeting masks and other unpractical devices. Simply open the sample viewing port and you can exactly see what you're aiming at. Even on very dark colors, the very bright special illumination LED shows you exactly what you'll measure, whether you're using the large or the small aperture mask. Once you have positioned the CM-2600d, just let the lever go and take the measurement.

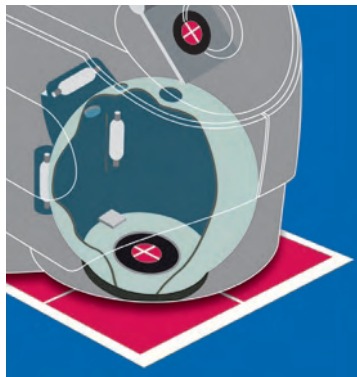

5 Fits comfortably into your hand :

Weighing only 670 gr. (without batteries) and combined with its ergonomic design, the CM-2600d is perfectly suited for any application in the laboratory in the field. Taking measurements horizontally or vertically is both easy and fatigue free. The compact size and accessible measurement aperture allows you to measure samples of any shape or size.



2 Comprehensive and informative color Data Information Display:

The large Display is your "Information Centre". Displaying data graphically or numerically, it shows you the facts about your colors at a glance. Whether you select simple Pass/Fail indications, colorimetric data with descriptive color difference, or L*a*b* color graph with either box or elliptical tolerances, – you're in control at any time. And also Relativity Gloss Value can be displayed by using Numerical Gloss Control. The internal software contains all necessary colorimetric equations and standard light sources to cover your tasks as well as numerous industry and application specific indices.

The internal software communicates in six languages (English, German, French, Italian, Spanish and Japanese) and thus is prepared for your international color communication network. It even reminds you when it is time for a factory re-calibration to ensure traceability to ISO-9000 recommendations.



Pass / Fail Display

Relativity Gloss Value

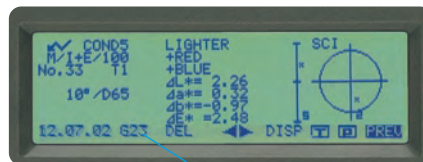

Color graph + data Display

Relativity Gloss Value



Simultaneous color difference with wording for SCI and SCE

Relativity Gloss Value

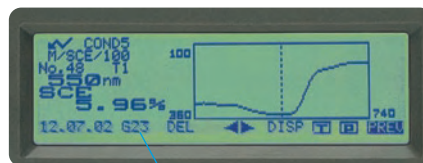

Spectral graph

Relativity Gloss Value

3 You'll never be out of power

With the CM-2600d, you have the free choice of three different power sources (batteries, rechargeable batteries or AC power), making your portable instrument ready for action at any time in any place. No need to wait for charging or being out of power at the wrong moment.

6 Two measuring apertures to cover all sample sizes:

The CM-2600d offers you great flexibility of use with two interchangeable measurement apertures with \varnothing 8 mm (MAV) and – \varnothing 3 mm (SAV). Changing the aperture mask is very easy and quick. The two lens position settings guarantee perfect data correlation with both apertures, – as you can expect from a leading-optical precision manufacturer. These two apertures enable you to measure samples of all size and shapes and avoid taking time consuming average measurements on structured surfaces or faulty results on small samples.



NORTH, EAST, SOUTH, WESTWARD HO! EXPANDING THE BOUNDARIES TO A GLOBAL COLOR DATA COMMUNICATION NETWORK.

In today's global network, customers, manufacturers and numerous suppliers have to work hand in hand when it comes to Total Quality Assurance. Reliable and correlating color data are a real challenge for flawless color communication in the whole manufacturing process, from R&D to Production and Quality Assurance. KONICA MINOLTA, one of the global leading manufacturers of color measuring systems and pioneer in portable spectrophotometers offers you the most extensive and complete range of instruments to meet this challenge.

The new CM-2600d, a highly interactive portable color measuring instrument, fits perfectly into KONICA MINOLTA's broad range of color measuring systems. The perfect inter-instrument agreement with the line of bench-top instruments as well as the commonly shared line of software, create a total solution system, suited for all stages in the manufacturing process throughout all kinds of applications. It is therefore not just a new fine piece of hardware, but also the expansion into a new generation of instrumentation linked with the world of Information Technology.

The issue: color data communication in a network

When it comes to color data communication within your company or in combination with your customers and suppliers, then the main issue is inter-instrument and inter-model agreement. These two terms describe the level of measurement data agreement between several instruments or the same type and/or several different models. The better this agreement is, the more it is possible to exchange color data within the network for flawless Quality Control. Through accurate design of all optical parts in full accordance with international norms and severe quality control levels, KONICA MINOLTA has earned the highest reputation for best inter-instrument and inter-model agreement levels. So you can choose a bench-top instrument for the laboratory and confidently exchange data with the CM-2600d in the Production and Quality Assurance department.

Network construction for color control either within an organisation or between organisations

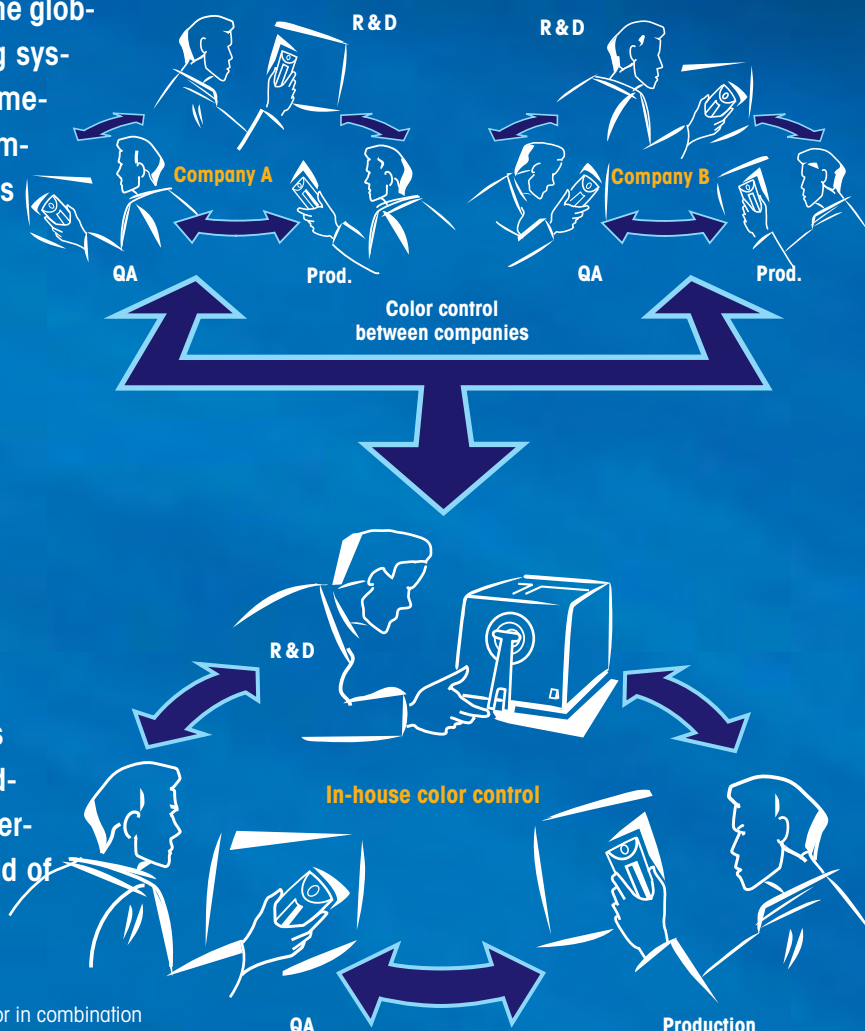

SpectraMagic™ **NX** (optional)

Supports Windows®2000/XP/Vista

SpectraMagic™ **NX** enables you to perform comprehensive color inspection and analysis of incoming raw materials, in process production, and outbound color critical goods and materials in virtually any industry. With SpectraMagic™ **NX** you can insert digital images with measured data. Measure samples in any of 8 universally accepted color spaces. Select from 15 illuminants, and up to 40 indices to determine specific color and appearance properties, such as strength, brightness, haze, yellowness, opacity and strength. You can even configure up to 3 customized color equations. Reports range from simple Pass/Fail to trend charts, histograms, color plots, and spectral graphs. SpectraMagic™ **NX** comes with predefined templates using skin technology, or you can create your own templates. For illustrations and explanations to understanding color and color measurement technology, there is a link to Konica Minolta's well known and respected "Precise Color Communication". Step by step navigation help.

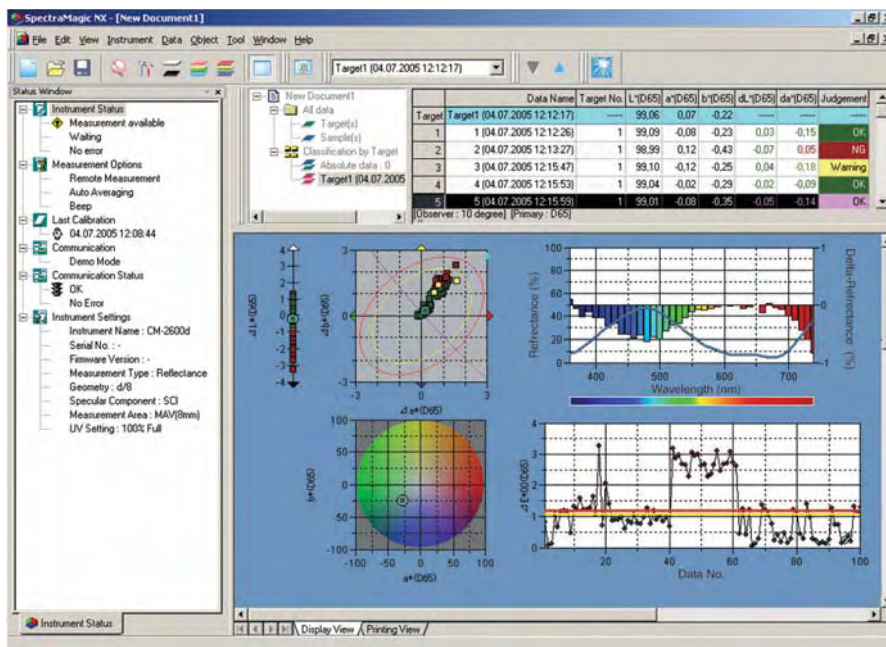

- Windows® is a trademark of Microsoft Corporation in the USA and other countries.

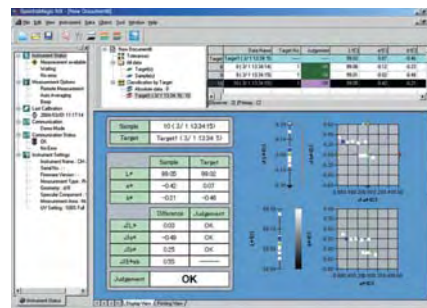
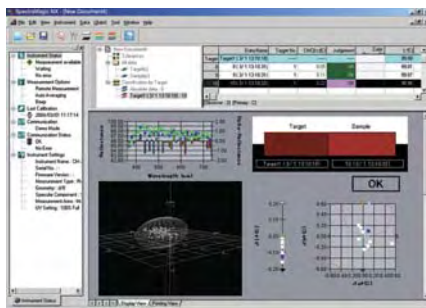

PEOPLE OFTEN TALK ABOUT "INNER VALUES". HERE THEY CAN FIND LOTS OF THEM.

Isn't it the wish of every user to master highly sophisticated instruments with absolute ease? Or is this a fantasy, which will never come true? Our answer to these questions is the new—portable spectrophotometer, the CM-2600d. It combines very simple, comfortable and intuitive use with KONICA MINOLTA's patented Innovative Optical System to meet the highest expectations for color measurement for Quality Assurance of almost any application.

Initially launched with the bench-top spectrophotometer CM-3600d, this innovative technology includes Numerical Gloss- Control (NGC) and, now available for the first time in a portable instrument, numerical UV-Control (NUVC).

Together with the high energy xenon flash illumination and the high resolution monolithic dual beam monochromator, this technology is free from moving parts and therefore guarantees substantial advantages in ruggedness and reliability.

World first: Numerical UV-Control

The CM-2600d is the world's first portable instrument to offer the patented numerical UV-Control (NUVC). This innovative technology drastically reduces calibration and measurement procedure time when measuring products treated with optical brighteners such as Textiles, Papers and Detergents. Instead of using the mechanically driven filters of traditional methods, the NUVc technology uses two xenon flashes (one including UV and one excluding UV energy) and special mathematics. Within a few seconds you get both results, with and without UV as well as under different illumination conditions.

UV-calibration procedure requires optional SpectraMagic™ NX software.

Unequaled: Numerical Gloss Control

Another patented and therefore exclusive – feature is the Numerical Gloss Control (NGC), which, for each measurement, provides simultaneous data with specular component included (SCI) and excluded (SCE). Instead of mechanical moving parts, NGC sequentially fires two xenon flashes, for SCI and SCE. At any time, you can display both measuring results in the display of the CM-2600d. NGC technology has also enable the achievement of Relativity Gloss Value display. The advantages of NGC technology lies in its superior optical results as well as the absence of any moving parts making the CM-2600d rugged enough for portable applications.

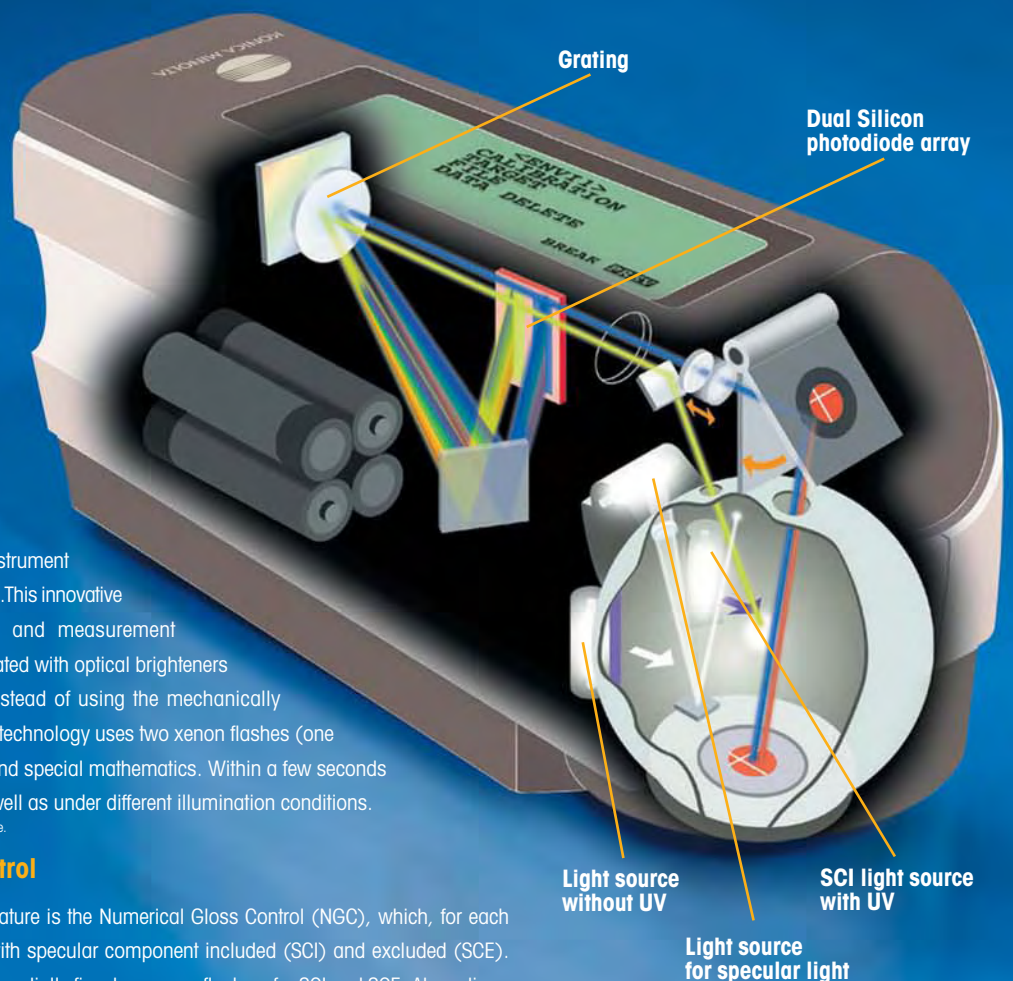

On suitability in accordance with international Standards:

The optical construction has great importance on subjects like absolute accuracy, data compatibility with other (type, brand) instruments. They depend on the way the supplier designs and manufactures all optical parts such as the geometry, light dividing devices, monochromator.

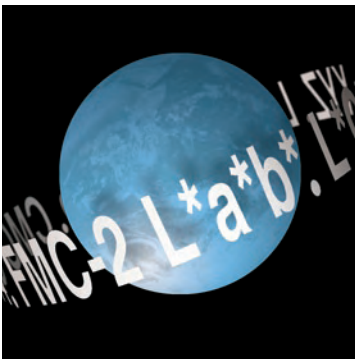
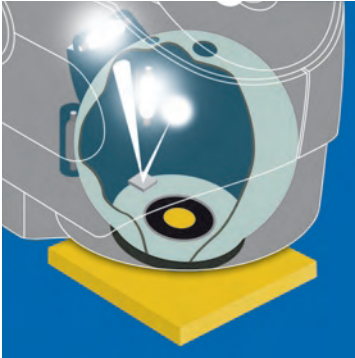

On suitability for all kind of samples:

Samples you have to control come in all sorts of shapes, sizes and forms, which the instrument should be able to measure in an easy and repeatable way. Furthermore, time-consuming sample preparation prior to measurement should be avoided by the instrument's ability to measure it as it is.

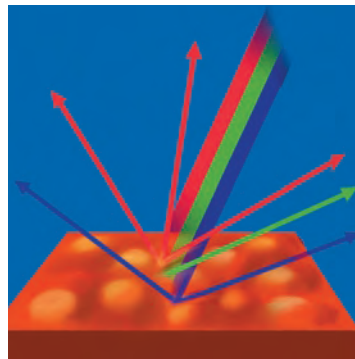

On Color data information:

The way color data is output and presented is a vital factor in ensuring quick and easy routine quality control in production. A large easy to read display, fast assessment Pass/Fail indications, including understandable color descriptions in your language, as well as display of color and spectral graphs, makes the instrument understandable to all operators regardless of their color knowledge.

On inter-instrument agreement:

Optimum performance is not a luxury, and you need to ensure you get reliable data throughout the instrument's lifetime. Many of your existing and future customers will undoubtedly have color measurement systems and will need to communicate with you about color data. Perfect inter-instrument agreement ensures data correlation between several instruments of the same type, whereas Inter-model agreement states the level of agreement between different types of instruments (e.g. portable and Bench-top instruments).

On specular evaluation

Depending on the surface condition of the sample and the angle of observation, the eye can perceive different levels of specular gloss (high gloss, semi-gloss or matte). To evaluate the influence of the gloss on the color data, the di:8°, de:8° geometry offers the ability to measure the sample including (SCI) or excluding (SCE) the specular component. Simultaneous assessment of SCI and SCE in one measurement offers great advantages in the speed and ease of use.

On Design & Ergonomics:

The design, shape, weight and ease of operation dictates if the instrument is "suitable" for your application. Its ergonomics, how it fits into your hand, are vital to the daily working practices and integration into the work process.

Today's standard requirements for portable color control:

- ✓ Optical system strictly in accordance with international standards (ISO, CIE, DIN, ASTM, AFNOR, JIS)
- ✓ Performances meeting your application for today and the future (repeatability, long term stability, inter-instrument agreement)
- ✓ Full and comprehensive color data information
- ✓ Compact, light, left or right handed operation
- ✓ Suitable for any shape or size of sample; Simultaneous SCI / SCE measurements

10 Additional features only the CM-2600d can offer you:

- Perfect sample observation with viewfinder
- Patented numerical Gloss control (NGC)
- Patented numerical UV calibration (standard equipment)
- Unique "Navigation wheel" for menu operation
- Intuitive operation flow
- Choice of six pre-selectable measurement modes
- Choice of three power supply modes (Batteries, rechargeable batteries, AC power)
- "Sleep mode" power saving system
- Yearly re-calibration reminder message



KONICA MINOLTA

SPECTROPHOTOMETER **NEW** CM-3600A/CM-3610A

Built for Precision. Compact yet powerful.



Plastics

Textiles

Paper

Liquids

Fine particles

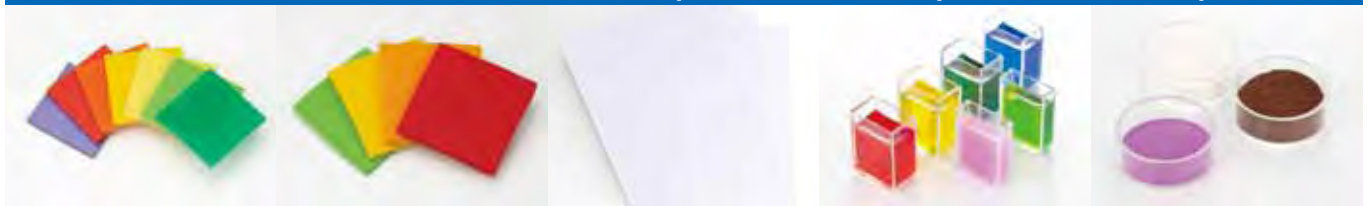

Outstanding Performance through Innovative Technology

CM-3600A Horizontal Spectrophotometer

- Highly accurate, reliable and rugged
- Versatile instrument for most colorimetric applications
- Simple operation

CM-3610A Vertical Spectrophotometer for best application support

- Speeds up textile and paper measurements
- Ideal for non-contact measurements such as powders, pigments
- Quick sample handling and measurement

The essentials of imaging

Spectrophotometers CM-3600A and CM-3610A

High-Accuracy Color Measurement in the Lab

Spectrophotometers CM-3600A and CM-3610A inherit the innovative Konica Minolta Innovative Optical System technology, maintaining their high accuracy and excellent performance while offering USB communication and other improvements.

* CM-3600A and CM-3610A are computer-controlled. Software such as optional SpectraMagic™ **NX** required.

Simultaneous SCI/SCE measurement

By firing two xenon lamps in quick succession, the patented Numerical Gloss Control (SCI/SCE) system of the CM-3600A and CM-3610A eliminates the need for a mechanical gloss trap while providing virtually simultaneous SCI and SCE measurements and enabling the calculation of 8° gloss.

SCI: Specular component included
SCE: Specular component excluded

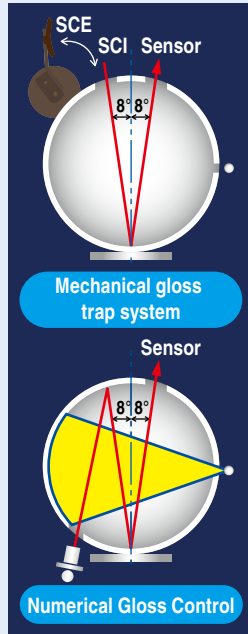
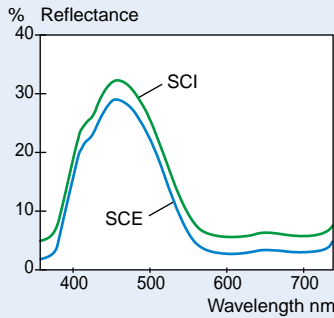

CM-3600A: Compact and fits easily on your desk

The CM-3600A has about the same footprint as a sheet of B4 paper so it can fit easily on your desk.



UV adjustment for accurate measurements of fluorescent materials

Accurate measurement of materials such as paper or cloth treated with fluorescent whitening agents (FWA) requires precise control of the UV component and its effects. The Numerical UV Control method used by the CM-3600A and CM-3610A provides such control by combining results from flashes of two xenon lamps (one with full UV energy, the other with UV energy removed by a 400 nm or 420 nm UV-cutoff filter) using proprietary calculations. This method eliminates the need for mechanical filter positioning, and enables UV adjustment by Whiteness Index, Tint, Brightness, or UV profile.

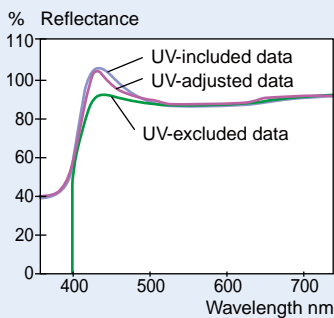

Brighter, clear sample viewing system



Opening the sample viewer provides a clear, illuminated view of the sample at the measurement port. On the CM-3600A, this view is reflected in a mirror so that you can view it easily even while seated.

Improved CM-3600A sample holder



Sample holder opens 90° for easy positioning of thick samples and is equipped with a "soft-close" mechanism that prevents it from slamming shut and possibly damaging samples.

CM-3610A: Laboratory and for Production

Technology used in the highly popular CM-3600d/CM-3610d,

Smallest footprint fits on your desk

Same footprint as laptop computer
where space is limited.

244 mm
9-5/8 in.



205 mm
8-1/16 in.



CM-3610A

3 measurement areas for diverse needs



Masks for the CM-3600A's three measurement areas (SAV: Ø4 mm, MAV: Ø8 mm, and LAV: Ø25.4 mm) are included as standard accessories, so you can select the one that fits your measurement requirements.

CM-3610A unique features

The vertical-type CM-3610A retains most of the features of the CM-3600A plus some unique features.

Sample holder - Easier handling of sheet materials



Direct measurement of powder materials



Reflectance and transmittance in one instrument

The CM-3600A/CM-3610A can measure both the reflectance of opaque objects and the transmittance of transparent or translucent solid materials such as plastics. With accessories, the CM-3600A can even measure the transmittance of liquids.

* Liquid measurements not possible with CM-3610A.



Reflectance Measurement: The CM-3600A/CM-3610A employs di:8°, de:8° geometry (diffuse illumination, 8° viewing) which conforms to ISO, CIE, ASTM, DIN, and JIS standards.



Transmittance Measurement: The CM-3600A/CM-3610A employs the d:0° geometry (diffuse illumination, 0° viewing), which conforms to ISO, CIE, ASTM, and DIN standards.



SpectraMagic™ NX (Optional)

Supports Windows®XP/Vista/7

SpectraMagic™ NX enables you to perform comprehensive color inspection and analysis of incoming raw materials, in-process production, and outbound color-critical goods and materials in virtually any industry. With SpectraMagic™ NX you can insert digital images with measured data. Measure samples in any of 8 universally accepted color spaces. Select from 16 illuminants, and up to 40 indices to determine specific color and appearance properties, such as strength, brightness, haze, yellowness, opacity and whiteness. You can even configure up to 8 customized color equations. Reports range from simple Pass/Fail to trend charts, histograms, color plots, and spectral graphs. SpectraMagic™ NX comes with predefined templates, or you can create your own templates. For illustrations and explanations to understanding color and color measurement technology, there is a link to Konica Minolta's well-known and respected "Precise Color Communication", as well as step by step navigation help.

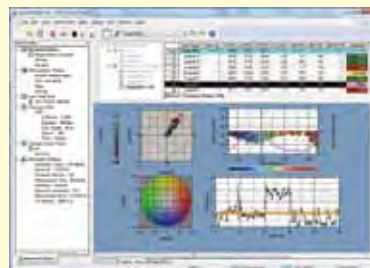

• Windows® is a trademark of Microsoft Corporation in the USA and other countries.

System Diagram

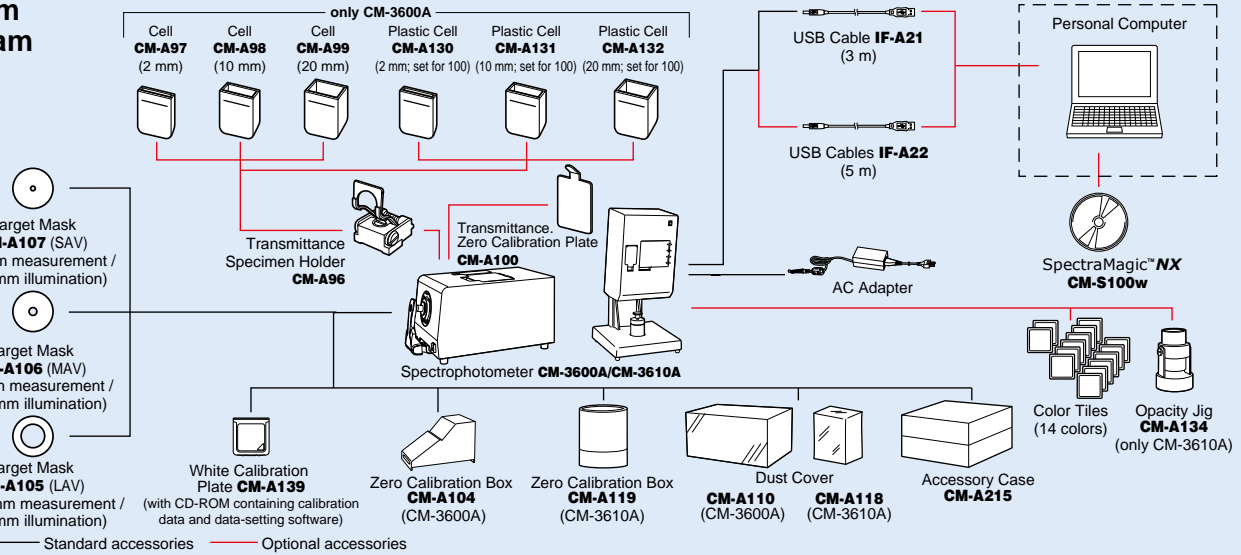

Specifications

Measuring geometry	Reflectance	di:8°, de:8° (diffused illumination, 8-degree viewing) Simultaneous measurement of SCI (specular component included) / SCE (specular component excluded)	Repeatability When white calibration plate is measured 30 times at 10-sec. intervals after white calibration has been performed; Spectral reflectance: Standard deviation within 0.1%; Colorimetric values: Standard deviation within ΔE*ab 0.02
		Conforms to CIE No.15, ISO 7724/1, ASTM E 1164, DIN 5033 Teil 7 and JIS Z 8722 condition c standard.	
	Transmittance	di:0°, de:0° (diffused illumination, 0-degree viewing) Conforms to CIE No.15, ASTM E 1164 and DIN 5033 Teil 7 and JIS Z 8722 condition g standard.	Inter instrument agreement Mean ΔE*ab 0.15 (SCI) Average for 12 BCRA Series II color tiles compared to values measured with master body.
Light-receiving element	Silicon photodiode array (dual 40 elements)		UV adjustment Instantaneous numerical adjustment
Spectral separation device	Diffraction grating		UV cut filter 400 nm cutoff and 420 nm cutoff
Wavelength range	360 to 740 nm		Transmittance chamber Width: 133 mm; depth: approx. 50 mm; measurement dia.: Transmission sample holder (Optional accessory): Sample holder for both plate-shaped and liquid samples (removable)
Wavelength pitch	10 nm		
Half bandwidth	Approx. 10 nm		Interface USB 1.1
Reflectance range	0 to 200%; resolution: 0.01%		Power AC100 to 240 V 50/60 Hz (Using included AC adapter)
Sphere size	ø152 mm		Operating temperature/humidity range (*1) 13 to 33°C, relative humidity 80% or less (at 33°C) with no condensation
Light source	4 pulsed xenon lamps		Storage temperature/humidity range 0 to 40°C, relative humidity 80% or less (at 35°C) with no condensation
Minimum interval between measurements	Normal SCI/ SCE measurement: 4 sec. Transmittance measurement: 3 sec. UV-cut/ UV-adjusted measurement: 5 sec.		Size (WxHxD) CM-3600A 244 x 205 x 378 mm, CM-3610A 300 x 597 x 315 mm
	illumination/ measurement area	Reflectance	Weight CM-3600A 11.5 kg, CM-3610A 16.5 kg
Transmittance		Changeable between SAV, MAV, and LAV SAV : ø7 mm illumination / ø4 mm measurement MAV : ø11 mm illumination / ø8 mm measurement LAV : ø30 mm illumination / ø24.5 mm measurement ø24 mm / Approx. ø17 mm	

*1 Operating temperature/humidity range of products for North America : 13 to 33°C, relative humidity 80% or less (at 31°C) with no condensation

- Displays shown are for illustration purposes only.
- The specifications and drawings given here are subject to change without prior notice.
- KONICA MINOLTA and the Konica Minolta logo and the symbol mark, and "The essentials of imaging" are registered trademarks or trademarks of KONICA MINOLTA HOLDINGS, INC.

Worldwide support network



SAFETY PRECAUTIONS

For correct use and for your safety, be sure to read the instruction manual before using the instrument.

- Always connect the instrument to the specified power supply voltage. Improper connection may cause a fire or electric shock.



Certificate No : LRQ 09600941A Certificate No : JQA-E-80027
Registration Date : March 3, 1995 Registration Date : March 12, 1997

KONICA MINOLTA SENSING, INC.
Konica Minolta Sensing Americas, Inc.
Konica Minolta Sensing Europe B.V.

Osaka, Japan
New Jersey, U.S.A.
European Headquarter / BENELUX
German Office
French Office
UK Office
Italian Office
Swiss Office
Nordic Office
Polish Office
SE Sales Division
Beijing Branch
Guangzhou Branch
Chongqing Office
Qingdao Office
Wuhan Office

Konica Minolta (CHINA) Investment Ltd.

Konica Minolta Sensing Singapore Pte Ltd.
KONICA MINOLTA SENSING, INC.

Addresses and telephone/fax numbers are subject to change without notice. For the latest contact information, please refer to the KONICA MINOLTA SENSING Worldwide Offices web page :

Phone : 888-473-2656 (in USA), 201-236-4300 (outside USA)
Nieuwegein, Netherlands **Phone :** +31(0)30 248-1193
München, Germany **Phone :** +49(0)89 4357 156 0
Roissy CDG, France **Phone :** +33(0)1 80 11 10 70
Warrington, United Kingdom **Phone :** +44(0)1925 467300
Milan, Italy **Phone :** +39 02 39011.1
Dietikon, Switzerland **Phone :** +41(0)43 322-9800
Västra Frölunda, Sweden **Phone :** +46(0)31 7099464
Wroclaw, Poland **Phone :** +48(0)71 33050-01
Shanghai, China **Phone :** +86-(0)21-5489 0202
Beijing, China **Phone :** +86-(0)10-8522 1551
Guangdong, China **Phone :** +86-(0)20-3826 4220
Chongqing, China **Phone :** +86-(0)23-6773 4988
Shandong, China **Phone :** +86-(0)532-8079 1871
Hubei, China **Phone :** +86-(0)27-8544 9942
Singapore **Phone :** +65 6563-5533
Seoul, Korea **Phone :** +82(0)2-523-9726

Fax : 201-785-2482
Fax : +31(0)30 248-1280
Fax : +49(0)89 4357 156 99
Fax : +33(0)1 80 11 10 82
Fax : +44(0)1925 711143
Fax : +39 02 39011.223
Fax : +41(0)43 322-9809
Fax : +46(0)31 474945
Fax : +48(0)71 734 52 10
Fax : +86-(0)21-5489 0005
Fax : +86-(0)10-8522 1241
Fax : +86-(0)20-3826 4223
Fax : +86-(0)23-6773 4799
Fax : +86-(0)532-8079 1873
Fax : +86-(0)27-8544 9991
Fax : +65 6560-9721
Fax : +82(0)2-523-9729

<http://konicaminolta.com/instruments/about/network>



KONICA MINOLTA

Spectrophotometer CM-5

An advanced all-in-one spectrophotometer with innovative operation to let anyone take measurements easily anytime



The CM-5 makes color measurements simple. Just switch it on and start taking measurements. No need to bother with a computer; the CM-5 has a full range of advanced functions including specialized indices for a variety of applications and a large color display that makes results easy to read.

Finally, high accuracy and ease of use in a compact top-port spectrophotometer!

The essentials of imaging

Measurements as simple as 1-2-3!



Switch on power.

The CM-5 starts up and **automatically performs white/100% calibration*** using an internal white calibration plate behind the shutter.

* Not applicable to liquid transmittance measurements using cells.



Position sample.

For reflectance, the **top port** makes measuring samples of various shapes and sizes easy. For transmittance, sliding open the CM-5 reveals a **large transmittance chamber**. Liquids can be measured using optional cells.



Press MEAS.

The measurement is taken and the results appear in the display. The **large color LCD** enables data to be shown not only numerically, but also on the colorimetric plots and spectral graphs that normally require a computer to display.

Actual CM-5 screens!

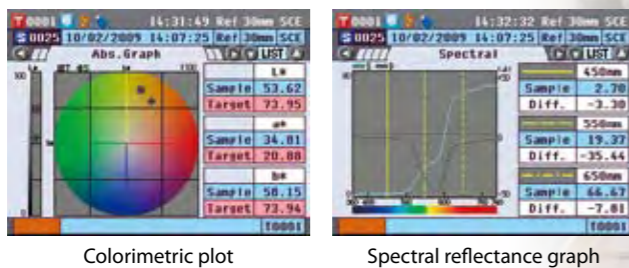

Colorimetric plot

Spectral reflectance graph

Screens can be shown in any of **7 languages**: English, Japanese, German, French, Italian, Spanish, and Simplified Chinese

Just follow the wizard!



Even beginners can take measurements easily without mistakes.

The CM-5's **wizard mode** guides users through each step, helping users to make settings and take measurements without having to get out the instruction manual each time.

Avoid multi-user confusion with USB!

Do many people in your lab use the same instrument? The CM-5 helps eliminate that confusion by letting users store their own settings on their own USB memory stick, so they can restore the settings they need by simply reading from the memory stick instead of going through and redoing settings individually. Afterwards when they're finished, they can store measurement and target data on the same USB key and take it with them for further analysis.



Afterwards when they're finished, they can store measurement and target data on the same USB key and take it with them for further analysis.

Compact, versatile color instrument

Reflectance measurements

The measuring port of the CM-5 is on top, so users can just place a solid object on the port and press the MEAS. button. There's no need to clamp the sample in a sample holder, and there's no worry about the sample shifting position. And, by using a Petri dish (optional accessory), liquids, pastes, and powders can also be measured easily.



Samples are just placed on top, so even large samples can be measured.

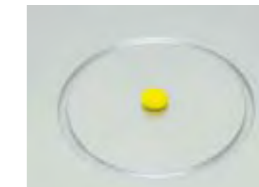

By using the Ø3mm target mask (optional accessory), even small samples can be measured.



Chunky materials can be put in a Petri dish (optional accessory) and measured.



Pastes can also be measured using a Petri dish (optional accessory).



Colorant pellets can be measured in raw form using a Petri dish (optional accessory).



Tiny amounts of costly samples can be measured using the mini dish (custom product).

Transmittance measurements

The CM-5's transmittance chamber is large and sideless, enabling measurements of even large sample sheets with thicknesses up to 60mm.

For liquids, optional cells with 3 optical path lengths for different sample densities are available, and commercial 10mm-wide cells can also be used.

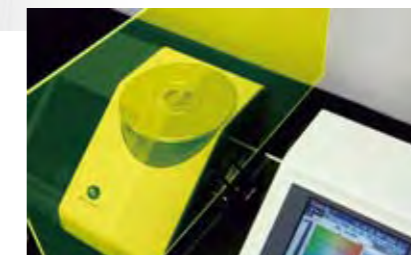

System Diagram

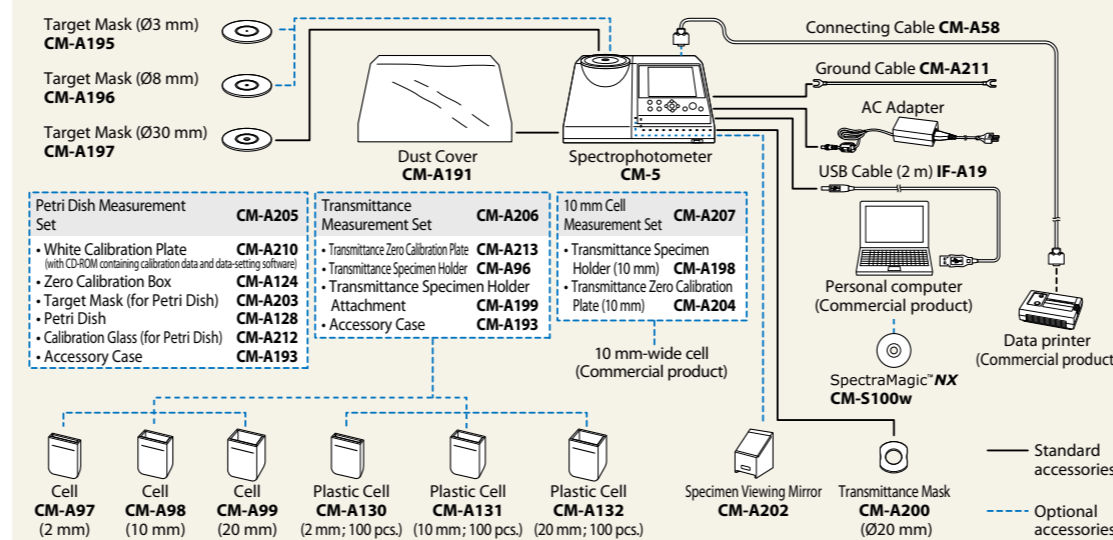

Petri Dish Measurement Set **CM-A205**



Transmittance Measurement Set **CM-A206**



10mm Cell Measurement Set **CM-A207**

Internal calibration curves for measuring standard chemical/pharmaceutical indices

The CM-5 can measure several of the standard color indices commonly used in the chemical and pharmaceutical field: Gardner, Hazen/APHA, Iodine Color Number, European Pharmacopoeia and US Pharmacopoeia. Calibration curves for these indices are stored in the CM-5, so measurements of samples based on these indices can be performed quickly and easily by anyone.



Main specifications

Model	Spectrophotometer CM-5	
Measuring geometry	Reflectance:	di:8°, de:8° (diffuse illumination: 8° viewing) SCI (specular component included)/SCE (specular component excluded) switchable Conforms to CIE No. 15, ISO 7724/1, ASTM E 1164, DIN 5033 Teil 7, and JIS Z 8722 condition c standard.
	Transmittance:	di:0°, de:0° (diffuse illumination: 0° viewing)
Integrating sphere size	Ø152 mm	
Detector	Dual 40-element silicon photodiode arrays	
Spectral separation device	Planar diffraction grating	
Wavelength range	360 nm to 740 nm	
Wavelength pitch	10 nm	
Half bandwidth	Approx. 10 nm	
Measurement range	0 to 175 % (Reflectance or transmittance); Output/display resolution: 0.01%	
Light source	Pulsed xenon lamp	
Measurement time	Approx. 1 s (to data display/output); Minimum measurement interval: Approx. 3 s	
Illumination/ Measurement area	Reflectance:	Changeable by changing mask and settings. LAV: Ø36 mm/Ø30 mm; MAV (optional): Ø11 mm/Ø8 mm; SAV (optional): Ø6 mm/Ø3 mm
	Transmittance:	Ø26 mm/Approx. Ø20 mm
Repeatability	Spectral reflectance: Standard deviation within 0.1% (400 nm to 740 nm) Chromaticity value: Standard deviation within ΔE^*ab 0.04 * When a white calibration plate is measured 30 times at 10-second intervals after white calibration	
Inter-instrument agreement	Within ΔE^*ab 0.15 (Typical) (LAV/SCI) (Based on 12 BCRA Series II color tiles compared to values measured with a master body under Konica Minolta standard conditions)	
Transmittance chamber	No sides (unlimited sample length); Depth (maximum sample thickness): 60 mm Sample holders (optional) for holding sheet samples or containers of liquid samples can be installed/removed	
Display	5.7-inch TFT color LCD	
Display languages	English, Japanese, German, French, Italian, Spanish, Simplified Chinese	
White/100% calibration	Automatic white (reflectance)/100% (transmittance) calibration using internal white calibration plate (Not applicable to 100% calibration when using cells for transmittance measurements of liquids.)	
Interfaces	USB 1.1 (Connection to PC; USB memory stick); RS-232C standard (Connection to serial printer)	
Observer	2° Standard Observer or 10° Standard Observer	
Illuminant	A, C, D50, D65, F2, F6, F7, F8, F10, F11, F12, ID50, ID65 (simultaneous evaluation with two light sources possible)	
Displayed data	Spectral values, spectral graph, colorimetric values, color-difference values, color-difference graph, pass/fail judgment, pseudo color, color assessment	
Color space	L*a*b*, L*C*h, Hunter Lab, Yxy, XYZ, Munsell, and color differences in these spaces (except for Munsell)	
Index	Reflectance:	MI; WI (ASTM E 313-73, ASTM E 313-96); YI (ASTM E 313-73, ASTM E 313-96, ASTM D 1925); ISO Brightness; B (ASTM E 313-73)
	Transmittance:	Gardner; Iodine Color Number; Hazen/APHA; European Pharmacopoeia; US Pharmacopoeia
User index	User-defined index	
Color-difference equation	ΔE^*ab (CIE 1976), ΔE^*94 (CIE 1994), ΔE_{00} (CIE 2000), ΔE (Hunter), CMC (l: c)	
Pass/fail judgment	Tolerances can be set to colorimetric values (except Munsell), color-difference values, or reflectance index values	
Storable data	Measurement data: 4,000 measurements; Target color data: 1,000 measurements	
USB memory stick* storage	Storage of measurement data and target color data. Storage/reading of measurement condition settings	
Power	AC 100 to 240 V, 50/60 Hz (using exclusive AC adapter)	
Size	Slide cover closed: 385 (W) × 192 (H) × 261 (D) mm Slide cover open: 475 (W) × 192 (H) × 261 (D) mm	
Weight	Approx. 5.8 kg	
Operating temperature/ humidity range	13 to 33°C, relative humidity 80 % or less (at 35°C) with no condensation	
Storage temperature/ humidity range	0 to 40°C, relative humidity 80 % or less (at 35°C) with no condensation	

* Security-enabled USB memory sticks cannot be used.



SAFETY PRECAUTIONS

For correct use and for your safety, be sure to read the instruction manual before using the instrument.

- Always connect the instrument to the specified power supply voltage. Improper connection may cause a fire or electric shock.
- Be sure to use the specified batteries. Using improper batteries may cause a fire or electric shock.

The specifications and drawings given here are subject to change without prior notice.
- If you have any questions about specifications, please contact your Konica Minolta representative.
The Konica Minolta logo and the symbol mark, and "The essentials of imaging" are registered trademarks or trademarks of KONICA MINOLTA HOLDINGS, INC. SpectraMagic is a registered trademark or a trademark of KONICA MINOLTA SENSING, INC.



Certificate No : LRQ 096009/4A
Registration Date : March 3, 1995



Certificate No : JQA-E-80027
Registration Date : March 12, 1997

KONICA MINOLTA SENSING, INC.
Konica Minolta Sensing Americas, Inc
Konica Minolta Sensing Europe B.V.

Osaka, Japan
New Jersey, U.S.A.
European Headquarter /BENELUX
German Office
French Office
UK Office
Italian Office
Swiss Office
Nordic Office
Polish Office

Konica Minolta (CHINA) Investment Ltd.

SE Sales Division
Beijing Branch
Guangzhou Branch
Chongqing Office
Qingdao Office
Wuhan Office

Konica Minolta Sensing Singapore Pte Ltd.
KONICA MINOLTA SENSING, INC.

Seoul Office

Addresses and telephone/fax numbers are subject to change without notice. For the latest contact information, please refer to the KONICA MINOLTA SENSING Worldwide Offices web page :

Phone : 888-473-2656 (in USA), 201-236-4300 (outside USA)
Nieuwegein, Netherlands
München, Germany
Roissy CDG, France
Warrington, United Kingdom
Milan, Italy
Dietikon, Switzerland
Västra Frölunda, Sweden
Wroclaw, Poland
Shanghai, China
Beijing, China
Guangdong, China
Chongqing, China
Shandong, China
Hubei, China
Singapore
Seoul, Korea

Fax : 201-785-2482
+31(0)30 248-1280
+49(0)89 4357 156 99
+33(0)1 80 11 10 82
+44(0)1925 711143
+39 02 39011.223
+41(0)43 322-9809
+46(0)31 474945
+48(0)71 734 52 10
+86-(0)21-5489 0005
+86-(0)10-8522 1241
+86-(0)20-3826 4223
+86-(0)23-6773 4799
+86-(0)532-8079 1873
+86-(0)27-8544 9942
+65 6563-5533
+82(0)2-523-9726

<http://konicaminolta.com/instruments/about/network>



KONICA MINOLTA

Spectrophotometer **NEW** CM-700d/600d

1

Compact, lightweight, portable spectrophotometer with wireless communication and color LCD screen

Field-oriented spectrophotometer for reliable color measurement

Unprecedented ease of handling and easy operation with color LCD screen



The essentials of imaging

CM-700d/600d: Compact, lightweight spectrophotometers with wireless communication and color LCD screen, offering excellent portability and operability!

We are surrounded by abundant colors. In the automotive, home appliance, portable phone, textile and clothing industries the variation in colors are increasing in order to differentiate products. In the food industry, the importance of color management continues to rise. Under such circumstances, the applications of color-measuring instruments have been rapidly spreading from R&D or QC departments to production sites, as well as from product manufacturers to parts/material suppliers.

The CM-700d/600d is a spectrophotometer that has achieved a much more compact and lightweight body while retaining the sophisticated functions of Konica Minolta's conventional models by utilizing our original optical design and signal processing technologies. It allows easy and accurate color measurement in various sites and occasions.

The easy-to-read color LCD screen allows intuitive recognition of measurement results. Experience the ease for yourself!

Perfect design to fit in your hand

- Ergonomic, compact and lightweight
- Vertical format for easy positioning
- Excellent portability for production sites



Measure anywhere!

The tapered measuring head allows for easy checking of measurement positions. The upright design ensures easy measurement, even on concave surfaces. The measuring aperture is selectable between ø8 mm and ø3 mm according to the sample size (CM-700d only).



Bluetooth® compatible!

Data can be sent to a PC or a mobile printer via Bluetooth® wireless communication. (USB communication with a PC is also possible.)



Automatic switching for SCI and SCE measurement

Large memory capacity

No. of storable data sets
Target data: 1,000 sets
Measurement data: 4,000 sets



Standard accessories



Optional accessories



Easy to operate!

Dedicated buttons for frequently used operations make it easy to call up menus or target colors. The menu-driven display allows anyone to operate the instrument intuitively.

Easy-to-read color LCD screen!

Abundant information is displayed in color for easy understanding. Measured colors can also be reproduced as color patches on the color LCD, which is useful to check the level of color difference or to search for colors.



Spectral graph

Pseudocolor

Color difference graph



Color Data Software SpectraMagic™ NX CM-S100w (Optional accessory)

(Version 1.8 or later)

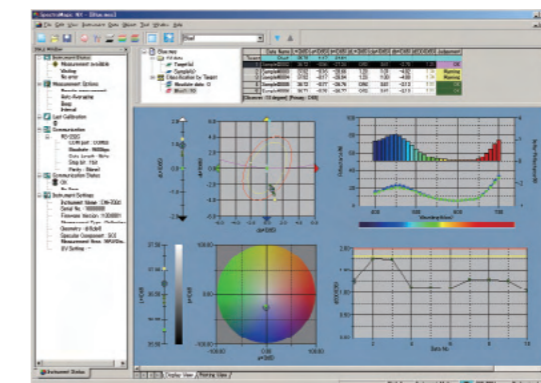

Screen creation according to the application

You can create screens suitable for your application by laying out and editing various objects including data lists, spectral graphs, color difference graphs and Pass/Fail displays. You can also create print screens to print inspection reports after measurements.

OS: Windows® 2000 Professional SP4, Windows® XP Professional SP2, x64 Edition, Windows® Vista Business 32 bit (x86), 64 bit (x64) **CPU:** Pentium® III 600 MHz equivalent or faster (recommended) **Memory:** 128 MB or more (256 MB or more recommended) **Hard disk:** 450 MB or more of free space for installation **Display:** Resolution: 1024 x 768 dots or more/ 256-bit colors or more **Other:** CD-ROM drive (required at software installation), USB port (required to connect the protect key), USB port or serial port (required to connect the instrument), Internet Explorer Version. 5.01 or higher installed in the computer.

• Windows® is a trademark or registered trademark of Microsoft Corporation in the USA and other countries. • Pentium® is a trademark of Intel Corporation in the USA and other countries. • The specifications given here are subject to change without prior notice.

<System Configuration>

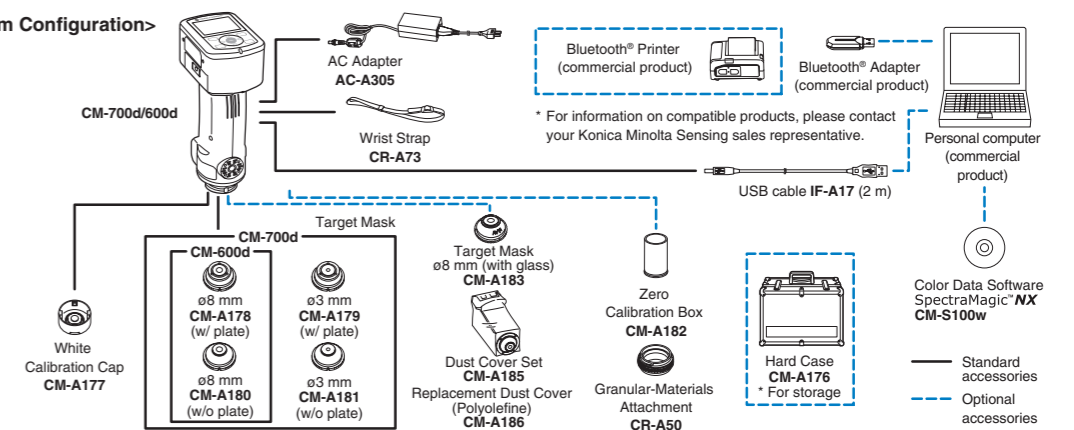

Main specifications

Model	CM-700d	CM-600d
Illumination/viewing system	di: 8°, de: 8° (diffused illumination, 8-degree viewing angle), SCI (specular component included)/SCE (specular component excluded) selectable with automatic switching (Conforms to CIE No. 15, ISO 7724/1, DIN5033 Teil7, ASTM E 1164, and JIS Z 8722)	
Size of integrating sphere	ø40 mm	
Detector	Silicon photodiode array (dual 36-element)	
Spectral separation device	Diffraction grating	
Wavelength range	400 nm to 700 nm	
Wavelength pitch	10 nm	
Half bandwidth	Approx. 10 nm	
Reflectance range	0 to 175%, Display resolution: 0.01%	
Light source	Pulsed xenon lamp (with UV cut filter)	
Measurement time	Approx. 1 second	
Minimum measurement interval	Approx. 2 seconds (in SCI or SCE mode)	
Battery performance	With alkaline dry batteries: Approx. 2,000 measurements With nickel-metal-hydride rechargeable batteries (2300 mAh): Approx. 2,000 measurements with full charge * Stand-alone continuous measurement fixed to either SCI or SCE mode at 10-second intervals at 23°C	
Measurement/illumination area	MAV: ø8 mm/ ø11 mm SAV: ø3 mm/ ø6 mm * Changeable by replacing target mask and selecting lens position	MAV: ø8 mm/ ø11 mm only
Repeatability	Spectral reflectance: Standard deviation within 0.1%, Chromaticity value: Standard deviation within ΔE^*ab 0.04 * When a white calibration plate is measured 30 times at 10-second intervals after white calibration	
Inter-instrument agreement	Within ΔE^*ab 0.2 (MAV/SCI) * Based on 12 BCRA Series II color tiles compared to values measured with a master body at 23°C	
No. of averaging measurements	1 to 10 (Auto averaging), 1 to 30 (Manual averaging)	
Display	2.36-inch TFT color LCD	
Interfaces	USB1.1; Bluetooth® standard version 1.2*	
Observer	2° observer or 10° observer	
Illuminant	A, C, D50, D65, F2, F6, F7, F8, F10, F11, F12 (Simultaneous evaluation with two light sources possible)	
Displayed data	Spectral values/graph, colorimetric values, color difference values/graph, PASS/FAIL result, pseudocolor, color assessment	
Color spaces	L*a*b*, L*C*h, Hunter Lab, Yxy, XYZ, Munsell, and color difference in these spaces (except for Munsell)	
Colorimetric data	MI, WI (ASTM E313-73/E313-96), YI (ASTM E313-73/ASTM D1925), ISO Brightness, 8° gloss value	
Color difference formulas	ΔE^*ab (CIE1976), ΔE^*94 (CIE1994), ΔE_{00} (CIE 2000), CMC (l: c)	
Storable data sets	Measurement data: 4,000 sets/Target color difference data: 1,000 sets	
Pass/fail judgment	Tolerances can be set to colorimetric values (excluding Munsell), color difference values, color values (excluding 8° gloss value) respectively	
Power	Special AC adapter; 4 AA-size alkaline dry batteries or nickel-metal-hydride rechargeable batteries	
Size	73 (W) x 211.5 (H) x 107 (D) mm	
Weight	Approx. 550 g (without white calibration cap and batteries)	
Operating temperature/ humidity range	5 to 40°C, relative humidity 80% or less (at 35°C) with no condensation	
Storage temperature/ humidity range	0 to 45°C, relative humidity 80% or less (at 35°C) with no condensation	

* Applicable Bluetooth® profile: Serial Port Profile, Output: Bluetooth® Power Class 1 The communication distance may vary depending on the obstacles and radio wave conditions between the devices. Successful wireless communication is not guaranteed with all Bluetooth®-ready equipment.

• Bluetooth® is a registered trademark of Bluetooth SIG, Inc. and is used under license agreement.

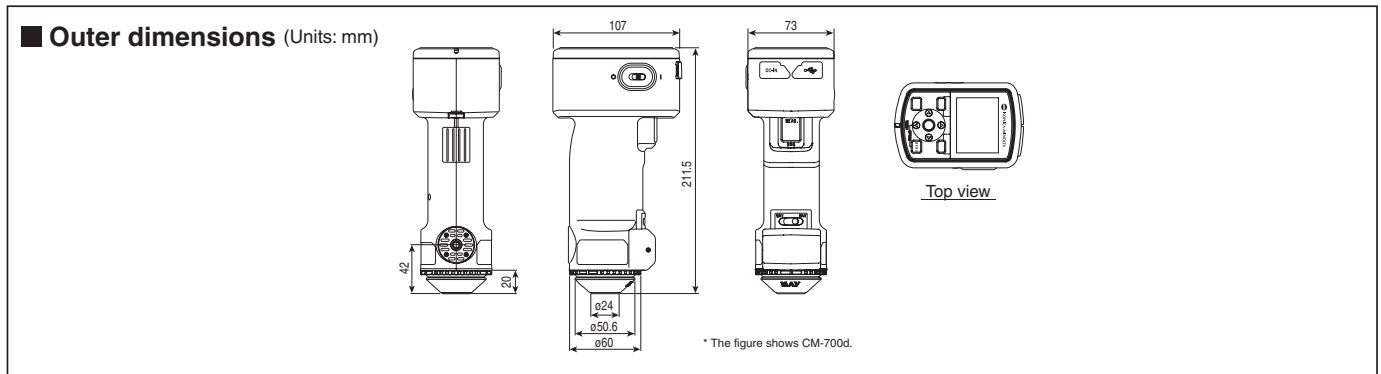

SAFETY PRECAUTIONS

For correct use and for your safety, be sure to read the instruction manual before using the instrument.

- Always connect the instrument to the specified power supply voltage. Improper connection may cause a fire or electric shock.
- Be sure to use the specified batteries. Using improper batteries may cause a fire or electric shock.

The specifications and drawings given here are subject to change without prior notice.
- If you have any questions about specifications, please contact your Konica Minolta representative.



Certificate No.: YKA 0937154
Registration Date: March 3, 1995



Certificate No.: JQA-E-80027
Registration Date: March 12, 1997

KONICA MINOLTA SENSING, INC.
Konica Minolta Sensing Americas, Inc.
Konica Minolta Sensing Europe B.V.

Osaka, Japan
New Jersey, U.S.A.
European Headquarter /BENELUX
German Office
French Office
UK Office
Italian Office
Belgian Office
Swiss Office
Nordic Office
Austrian Office
Polish Office

Konica Minolta (CHINA) Investment Ltd.

SE Sales Division
SE Beijing Office
SE Guangzhou Office

Konica Minolta Sensing Singapore Pte Ltd.
KONICA MINOLTA SENSING, INC.

Seoul Office

Phone : 888-473-2656(in USA), 201-236-4300(outside USA)

Nieuwegein, Netherland
München, Germany
Roissy CDG, France
Milan, Italy
Zaventem, Belgium
Dietikon, Switzerland
Västra Frölunda, Sweden
Wien, Austria
Warszawa, Poland
Shanghai, China
Beijing, China
Guangzhou, China
Singapore
Seoul, Korea

Phone : +31(0)30 248-1193
Phone : +49(0)89 630267-9700
Phone : +33(0)1 493-82519
Phone : +44(0)1908 540-622
Phone : +39 02 39011.425
Phone : +32 (0)2 7170 933
Phone : +41(0)43 322-9800
Phone : +46(0)31 7099464
Phone : +43(0)1 87882-430
Phone : +48(0)22 56033-00
Phone : +86-021-5489 0202
Phone : +86-010-8522 1551
Phone : +86-020-3826 4220
Phone : +65 6563-5533
Phone : +82(0)2-523-9726

Fax : 201-785-2480
Fax : +31(0)30 248-1280
Fax : +49(0)89 630267-9799
Fax : +33(0)1 493-84771
Fax : +44(0)1908 540-629
Fax : +39 02 39011.223
Fax : +32 (0)2 7170 977
Fax : +41(0)43 322-9809
Fax : +46(0)31 474945
Fax : +43(0)1 87882-431
Fax : +48(0)22 56033-01
Fax : +86-021-5489 0005
Fax : +86-010-8522 1241
Fax : +86-020-3826 4223
Fax : +65 6560-9721
Fax : +82(0)2-523-9729

Addresses and telephone/fax numbers are subject to change without notice. For the latest contact information, please refer to the KONICA MINOLTA SENSING Worldwide Offices web page:
©2007 KONICA MINOLTA SENSING, INC.

<http://konicaminolta.com/instruments/about/network>



KONICA MINOLTA

SPECTROPHOTOMETER CM-3700d

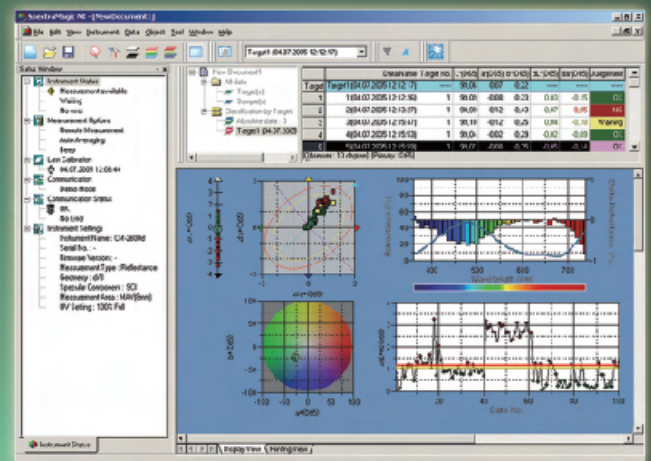

SpectraMagic™ NX (Optional)



The essentials of imaging

A High-Accuracy Benchtop Spectrophotometer With Konica Minolta's Optical Technology for High Performance and Computer Control for Easy Operation

Demands for higher accuracy and more analysis capabilities have been increasing, particularly from R&D professionals. In response, Konica Minolta has utilized its long experience in optics and color measurement to create the Spectrophotometer CM-3700d, a high-accuracy benchtop spectrophotometer suitable for not only research and development, but also for quality control or CCM applications.

High-speed, high-accuracy measurements

Measurements at wavelengths from 360 to 740nm at 10nm pitch are taken in approximately 0.6 seconds. Konica Minolta's optical technology ensures high absolute-value accuracy and repeatability, and extremely strict quality control provides higher inter-instrument agreement and reliability.

1 Illumination/viewing geometry meets ISO and DIN standards for di:8°, de:8° (diffuse illumination/8° viewing angle) geometry and also conforms to CIE and ASTM standards for d:0° (diffuse illumination/0° viewing angle) geometry.

2 Pulsed xenon lamp light source provides high stability, long life, and excellent repeatability on dark and high-chroma colors.

3 6-inch integrating sphere has a powdered barium sulfate (BaSO₄) coating with superior optical characteristics.

4 Double-beam feedback system monitors the light emitted by the xenon lamp and automatically compensates for changes in brightness or spectral characteristics.

5 Flat holographic grating efficiently separates the light by wavelength to provide higher repeatability for dark colors.

6 Silicon photodiode array sensor quickly converts the light separated by the grating to electrical currents.

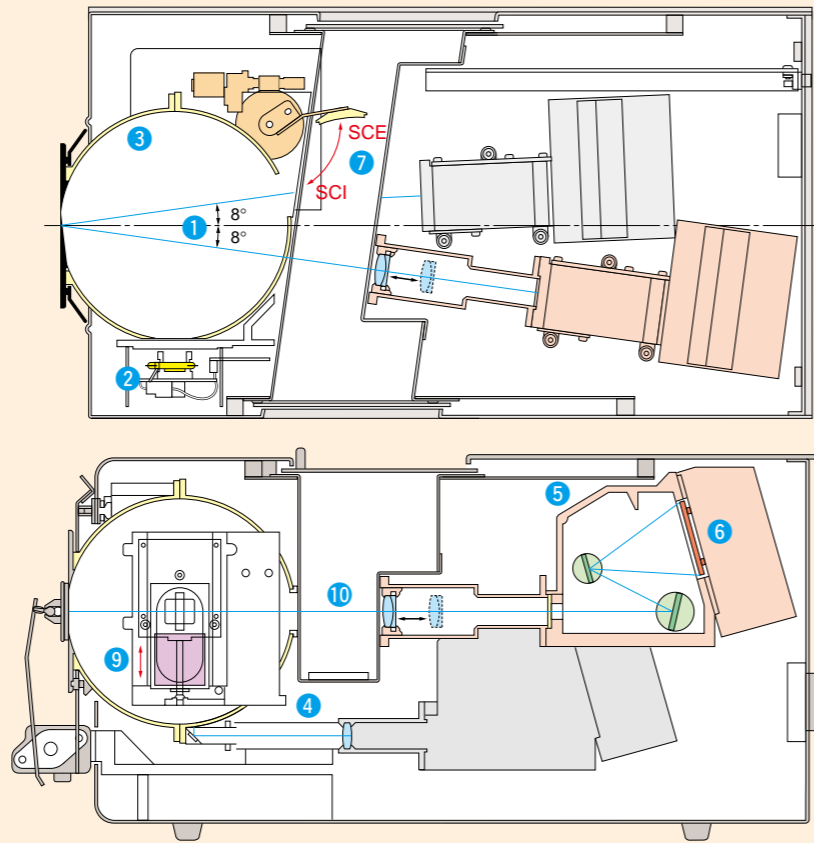

Various measuring functions

7 Switchable between SCI and SCE measurements

SCI (specular component included) measurements minimize the influence of surface conditions on measured values, making it suitable for CCM applications. SCE (specular component excluded) measurements correspond closely to professional visual evaluation.

8 Changeable measurement areas

Select measurement areas of 3x5mm, ø8mm, or ø25.4mm according to the application.

9 Variable UV

The amount of UV included in the illumination can be controlled in 1000 steps for measurements of fluorescent materials.

10 Transmittance measurements

The spectral transmittance of liquids or of specimens in sheet or plate form can be measured using di:0°, de:0° (diffuse illumination/0° viewing angle) geometry.

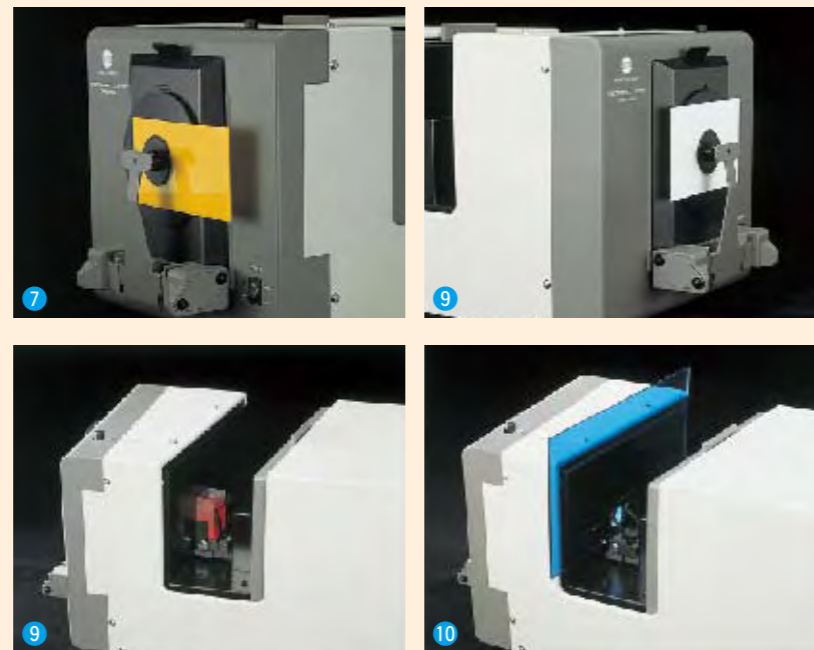

CM-3720d (Whiteness Model)/CM-3730d (Paper Industry Model)

UV cutoff filter switching (CM-3720d, CM-3730d)

Cuts off UV components having wavelengths of 420nm or less emitted by the light source. Useful for eliminating the effects of fluorescence when measuring fluorescent materials having excitation wavelengths below 420nm. Enables easy switching to normal measurement using illumination including ultraviolet radiation.

Low-illumination setting (CM-3720d, CM-3730d)

Reduces illumination level to one-fifth. Reduction of light quantity can eliminate triplet influences, which may occur occasionally when measuring fluorescent materials at the normal illumination level.

Opacity jig (CM-3730d)

Enables easy switching of the background between white and black and ensures paper position does not shift during opacity measurements.

SpectraMagic™ NX (optional)

Supports Windows®2000/XP/Vista

SpectraMagic™ NX enables you to perform comprehensive color inspection and analysis of incoming raw materials, in process production, and outbound color critical goods and materials in virtually any industry. With SpectraMagic™ NX you can insert digital images with measured data. Measure samples in any of 8 universally accepted color spaces. Select from 15 illuminants, and up to 40 indices to determine specific color and appearance properties, such as strength, brightness, haze, yellowness, opacity and strength. You can even configure up to 3 customized color equations. Reports range from simple Pass/Fail to trend charts, histograms, color plots, and spectral graphs. SpectraMagic™ NX comes with predefined templates using skin technology, or you can create your own templates. For illustrations and explanations to understanding color and color measurement technology, there is a link to Konica Minolta's well known and respected "Precise Color Communication". Step by step navigation help.

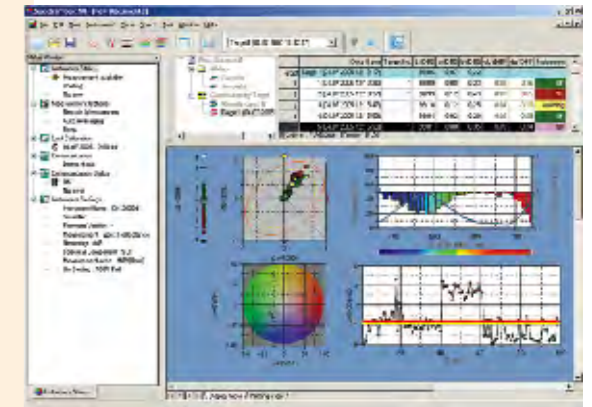

★ Windows® is a trademark of Microsoft Corporation in the USA and other countries.

System Diagram

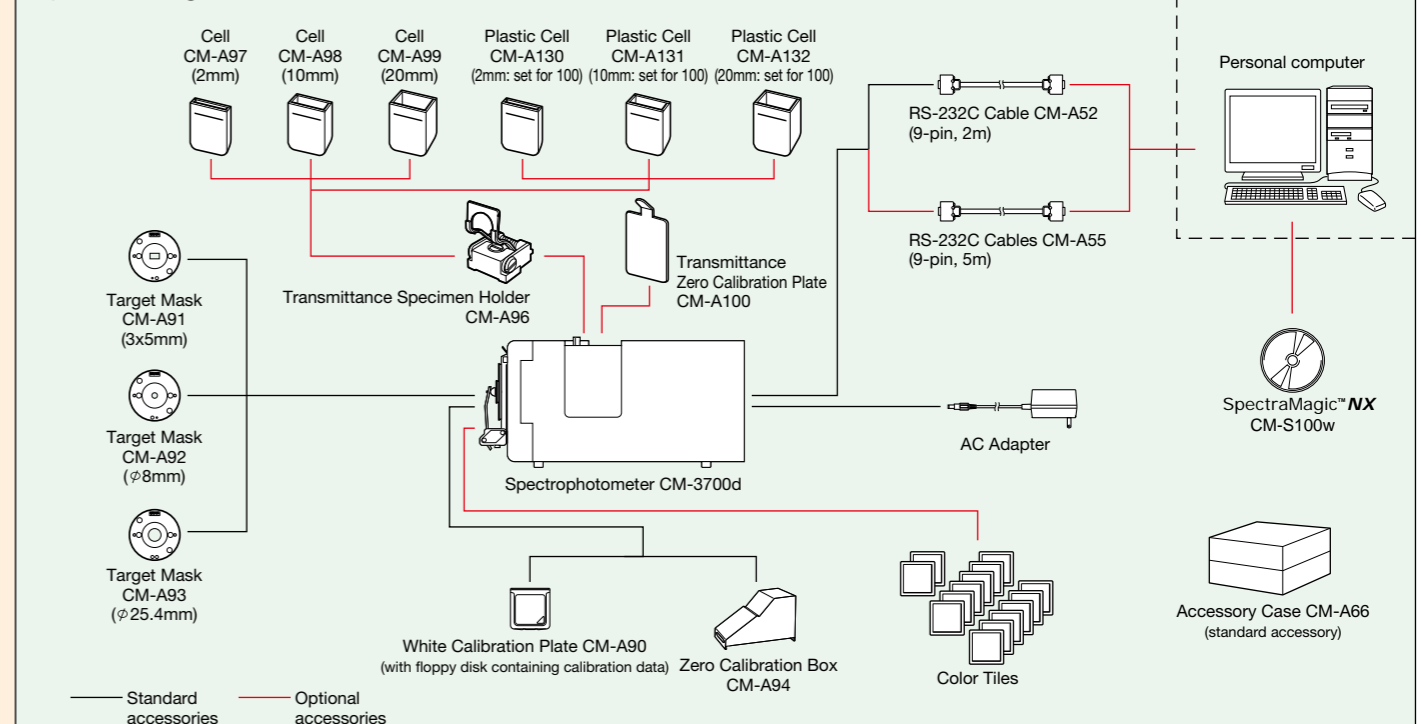

Optional Accessories

Transmittance Specimen Holder CM-A96

Holds specimens in place for transmittance measurements. Maximum specimen thickness: 22.5mm



Glass Cell CM-A97/CM-A98/CM-A99

Hold liquid specimens for transmittance measurements. Optical path lengths: 2mm (CM-A97), 10mm (CM-A98), and 20mm (CM-A99)

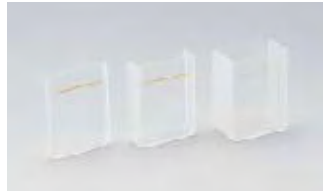

Plastic Cells CM-A130(2mm), CM-A131(10mm), CM-A132(20mm) are also available.

Transmittance Zero Calibration Plate CM-A100

For performing zero calibration for transmittance measurements.



Color Tiles

14 color tiles are available: White, Pale grey, Middle grey, Difference grey, Deep grey, Deep pink, Red, Orange, Bright yellow, Green, Difference green, Cyan, Deep blue, Black. Original materials of these tiles are supplied by BCRA.



Specifications (CM-3700d)

Measuring geometry	Reflectance: di:8°, de:8° (diffuse illumination/8° viewing angle); SCI (spectral component included) /SCE(spectral component excluded) switchable; meets CIE, ISO, ASTM, and DIN standards. Transmittance: di:0°, de:0° (diffuse illumination/0° viewing angle)
Detector	Silicon photodiode array with flat holographic grating
Wavelength range	360 to 740nm
Wavelength pitch	10nm
Half bandwidth	Approx. 14nm average
Photometric range	0 to 200%; Resolution: 0.001%
Light source	Pulsed xenon arc lamp
Measurement time	0.6 to 0.8 sec. (to start of data output)
Illumination/ measurement areas	Reflectance: Changeable between LAV, MAV, and SAV LAV: ø28mm illumination/ø25.4mm measurement MAV: ø11mm illumination/ø8mm measurement SAV: 5x7mm illumination/3x5mm measurement Transmittance: Approx. ø20mm
Repeatability	When white calibration plate is measured 30 times at 10-sec. intervals after white calibration has been performed: Spectral reflectance: Standard deviation within 0.05% Chromaticity: Standard deviation within ΔE*ab0.005 When black tile(BCRA Series II ; reflectance: 1%)is measured 30 times at 10-second intervals after white calibration has been performed: Spectral reflectance: 380 to 740nm: Standard deviation within 0.02% 360 and 370nm: Standard deviation within 0.04% Chromaticity: Standard deviation within ΔE*ab0.05
Inter-instrument agreement	mean ΔE*ab0.08 (typical) Average for 12 BCRA Series II color tiles. Max ΔE*ab0.3(corresponds to approx. ΔE*cmc 0.2) for any of 12 BCRA Series II color tiles compared to values measured with master body ; LAV.
Temperature drift	Spectral reflectance: Within ±0.10%/°C, Color difference: Within ±ΔE*ab0.05/°C
UV adjustment	Computer controlled: continuously variable
Specimen conditions for transmittance measurements	Sheet, plate, or liquid form up to a maximum thickness of approximately 50mm
Interface	RS-232C standard; baud rates: 1200,2400,4800,or 9600
Power	AC 100V/120V/230V 50/60Hz (using included AC adapter)
Operation temperature/humidity range (*1)	13 to 33°C, relative humidity 80% or less with no condensation
Storage temperature/humidity range	0 to 40°C, relative humidity 80% or less with no condensation
Dimensions (W×H×D)	271 × 259 × 500mm(10-11/16 × 10-3/16 × 19-11/16 in.)
Weight	18kg(39.7 lb.)
Standard accessories	White Calibration Plate; Target Mask(3x5mm); Target Mask(ø8mm); Target Mask(ø25.4mm); Zero Calibration Box; AC Adapter; RS-232C Cable(9-pin, 2m); Accessory Case CM-A66
Optional accessories	Transmittance Specimen Holder; Glass Cells(2mm, 10mm, 20mm); Plastic Cells(2mm, 10mm, 20mm); Transmittance Zero Calibration Plate; Color Tiles; RS-232C Cable(9-pin, 5m)

*1 Operating temperature/humidity range of products for North America : 13 to 33°C, relative humidity 80% or less (at 31°C) with no condensation

Dimensions

(Units:mm)

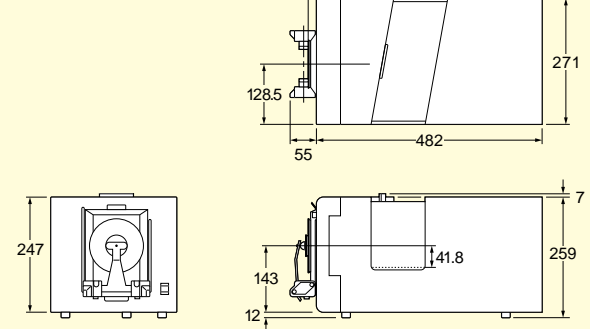

●Specifications are subject to change without notice.



Certificate No : YKA 0937154
Registration Date : March 3, 1995



Certificate No : JQA-E-80027
Registration Date : March 12, 1997



SAFETY PRECAUTIONS

For correct use and for your safety, be sure to read the instruction manual before using the instrument.

- Always connect the instrument to the specified power supply voltage. Improper connection may cause a fire or electric shock.

KONICA MINOLTA SENSING, INC.
Konica Minolta Sensing Americas, Inc
Konica Minolta Sensing Europe B.V.

Osaka, Japan
New Jersey, U.S.A.
European Headquarter /BENELUX
German Office
French Office
UK Office
Italian Office
Swiss Office
Nordic Office
Austrian Office
Polish Office

Phone : 888-473-2656(in USA), 201-236-4300(outside USA)

Nieuwegein, Netherland
München, Germany
Roissy CDG, France
Milton Keynes, United Kingdom
Milan, Italy
Dietikon, Switzerland
Västra Frölunda, Sweden
Wien, Austria
Warszawa, Poland

Shanghai, China
Beijing, China
Guangzhou, China
Singapore
Seoul, Korea

Fax : 201-785-2480

Fax : +31(0)30 248-1280
Fax : +49(0)89 630267-9799
Fax : +33(0)1 493-84771
Fax : +44(0)1908 540-629
Fax : +39(0)23 9011219
Fax : +41(0)43 322-9809
Fax : +46(0)31 474945
Fax : +43(0)1 87882-431
Fax : +48(0)22 56033-01

Konica Minolta (CHINA) Investment Ltd.
SE Sales Division
SE Beijing Office
SE Guangzhou Office

Konica Minolta Sensing Singapore Pte Ltd.

KONICA MINOLTA SENSING, INC. Seoul Office

Phone : +31(0)30 248-1193
Phone : +49(0)89 630267-9700
Phone : +33(0)1 493-82519
Phone : +44(0)1908 540-622
Phone : +39(0)23 90111
Phone : +41(0)43 322-9800
Phone : +46(0)31 7099464
Phone : +43(0)1 87882-430
Phone : +48(0)22 56033-00

Phone : +86-021-5489 0202
Phone : +86-010-8522 1551
Phone : +86-020-3826 4220
Phone : +65 6563-5533
Phone : +82(0)2-523-9726

Fax : +86-021-5489 0005
Fax : +86-010-8522 1241
Fax : +86-020-3826 4223
Fax : +65 6560-9721
Fax : +82(0)2-523-9729

Addresses and telephone/fax numbers are subject to change without notice. For the latest contact information, please refer to the KONICA MINOLTA SENSING Worldwide Offices web page :

<http://konicaminolta.com/instruments/about/network>



KONICA MINOLTA

SPECTROPHOTOMETER **CM-2500c**

**A breakthrough in 45/0 optics with
unprecedented accuracy & stability**



- Innovative 45/0 geometry optics
- Most lightweight, compact and rugged in its class
- 360-740 nm wavelength range, 10 nm resolution
- Single-handed operation with "Navigation wheel"
- Free choice of power source : AC adapter or AA batteries

The essentials of imaging

Compact, Lightweight, 45/0 Portable Spectrophotometer Offering High Measurement Stability

The CM-2500c is a 45/0 model that utilizes the same high accuracy, precision and portability as Konica Minolta's sphere-based CM-2600d and CM-2500d.

The CM-2500c is best suited for color measurement of samples such as automotive interior parts, coil coatings, plastics, paint, packaging, and raw materials. The 45/0 viewing optics correlate closely with visual perception of objects.

The innovative optical system ensures perfect annular illumination for best repeatability and stability.



The Innovative Optical System...

The optical design of the CM-2500c assures maximum reproducibility and stability of measurement during actual use. It also minimizes data fluctuation during repeated color measurements and improves the accuracy of the output.

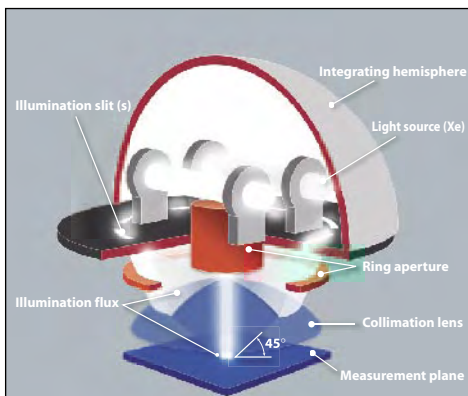

The mixing box (integrating hemisphere) and the illumination slit create a ring-shaped light source, achieving more uniform illumination, and thus more ideal 45/0 geometry than conventional systems.

Traditional 45/0 spectrophotometers are subject to fluctuation in measured values for samples with uneven and eroded surfaces.

The CM-2500c achieves highest stability by adopting an innovative optical system.

Fits your hand like a glove



The additional collimation lens provides highly parallel illuminating and receiving light beams and thus uniformity within the area.

The large sample contact area offers close and stable contact, ensuring easy measurement of samples with curved surfaces such as automotive parts or soft samples.

Weighing only 670 g (without batteries) and ergonomically designed, the CM-2500c is perfectly suited for any application in the laboratory, in the plant or in the field. Taking measurements horizontally or vertically is both easy and fatigue-free. The compact size and easy-to-align aperture allows you to measure samples of any shape or size.

...the Benefits are Yours

- Higher uniformity of illumination distribution (less uneven intensity in the illumination area)
- Perfect circle illumination area (not an ellipse)
- Ring-shaped illumination (no direction dependency)
- Improved reproducibility of measurements
- Less influence by changes in measuring position, instrument rotation sample position or sample angle

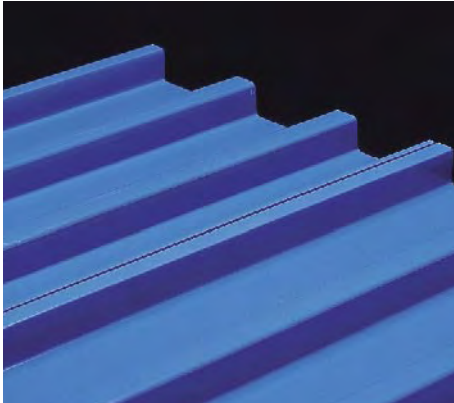

The CM-2500c: A real multi-talent for special tasks

The CM-2500c is fully equipped with hardware and software features to cover a wide range of applications where 45/0 geometry is either recommended or specified by applications such as automotive interior plastic and textile parts, solid paints (VDA ¹), Coil Coating (ECCA ²), high-visibility clothing (EN-471 ³), printing & packaging (TAPPI 1524 ⁴), Clay and Calcium Carbonate (TAPPI 646 ⁴) or road markings (ASTM D4956-4960 ⁵). The CM-2500c 45/0 geometry conforms to the following norms: CIE No.15, ISO 7724/1, ASTM E179, DIN 5033 Part 7 and JIS Z 8722.

¹ Verband der Automobilindustrie, ² European Coil Coating Association, ³ European Standard, ⁴ Technical Association of Pulp and Paper Industry, ⁵ American Society for Testing and Materials



Pass /Fail Display



Color graph + data Display



Absolute + Color difference display

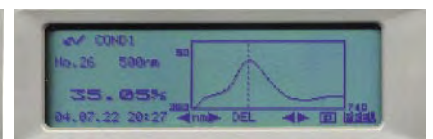

Spectral graph

Single-handed operation

Forget all you have heard about “easy operation” of any portable spectrophotometer so far! The new CM-2500c sets the standard for a simple and fast handling instrument. The exclusive "Navigation wheel" and the measuring button are placed right where your hand fits. The Navigation wheel "guides" you through all the menu operations with great ease. Use the wheel like a PC mouse, moving it forward or backward to select and pressing it down to click on the selection.

Comprehensive color Information Display

The large display is your “Information Center”. Displaying data graphically or numerically, it shows you the facts about your colors at a glance. Whether you select simple Pass/Fail indications, colorimetric data with descriptive color difference or L*a*b* color plot with either box or elliptical tolerances or spectral graph – you’re in control at any time. The internal software contains all necessary colorimetric equations and standard light sources to cover your tasks as well as numerous industry and application-specific indices.

The internal software communicates in six languages (English, German, French, Italian, Spanish and Japanese) and thus is prepared for your international color communication network. It even reminds you when it is time for a factory re-calibration to ensure traceability to ISO 9000 recommendations.

Color Data Software SpectraMagic™**NX** (optional)

Supports Windows® 2000/XP

In combination with the optional Color Data Software SpectraMagic™**NX**, the CM-2500c becomes a complete Quality Control and Color Management System. The software allows you to configure the graphic and numerical layout according to your needs, from ultra-simple Pass/Fail assessments to more sophisticated analysis with spectral, color and trend graphs. The unique Navigation function of SpectraMagic™**NX** is another useful feature to assure fast and easy use. To improve color communication with your customers and suppliers, SpectraMagic™**NX** allows you to insert digital pictures in printed reports—another unique feature.

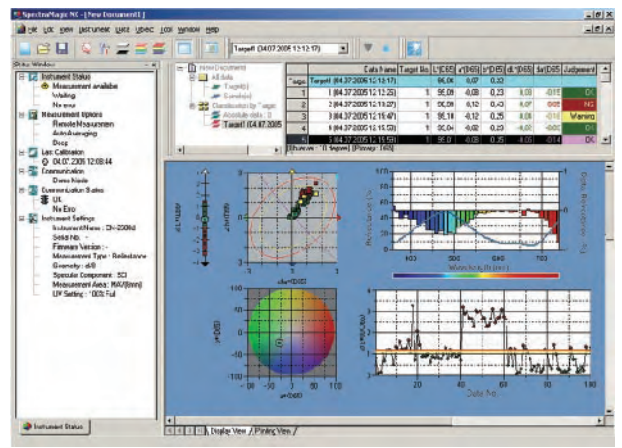

Specifications

Model	Spectrophotometer CM-2500c
Illumination/observation system	45/0 method (45° ring-shaped illumination, vertical viewing)
Light-receiving element	Silicon photodiode array (dual 40 elements)
Spectral separation device	Diffraction grating
Wavelength range	360 nm to 740 nm
Wavelength pitch	10 nm
Half bandwidth	Approx. 10 nm
Reflectance range	0 to 175%, resolution: 0.01%
Light source	2 pulsed xenon lamps
Measurement time	Approx. 1.5 seconds
Minimum interval between measurements	4 seconds
Battery performance	Alkaline manganese: Approx. 1000 measurements, (at 23°C)
Measurement/illumination area	ø7 mm/ø11 mm
Repeatability	Colorimetric Value: Standard deviation within ΔE*ab 0.05 (Measurement conditions: White calibration plate measured 30 times at 10-second intervals after white calibration was performed)
Inter instrument agreement	Within ΔE*ab 0.25 (Average for 12 BCRA Series II color tiles compared to values measured with master body; at 23°C)
Measurement mode	Single measurement/automatic averaging of multiple measurements (auto mode: 3, 5, 8 times/manual mode)
Interface	RS-232C standard
Observer	2/10 degrees (CIE 1931/2°, CIE 1964/10°)
Illuminant	A, C, D50, D65, F2, F6, F7, F8, F10, F11, F12 (simultaneous evaluation is possible using two light sources)
Display data	Spectral value/graph, colorimetric value, color difference value/graph, PASS/FAIL result, ASSESSMENTS (Except for Japanese mode)
Color space/colorimetric data	L*a*b*, L*C*h, CMC(1:1), CMC(2:1), CIE94, Hunter Lab, Yxy, Munsell, XYZ, Mi, WI (ASTM E313), WI (CIE), YI (ASTM E313/ASTM D1925), ISO Brightness (ISO 2470), Density status A/T, WI/Tint (CIE), CIE00
Data memory	1700 pieces of data (as SCI/SCE 1 data) * 700 pieces of data in the "defined in COND." mode. * Total of the sample data and color difference target data
Pass/Fail judgment	Tolerance for color difference (Both box and elliptical tolerances can be set)
Power source	4 AA-size batteries or AC adapter
Size (W x H x D)	69 x 96 x 193 mm
Weight	Approx. 670 g (without batteries)
Operating temperature/humidity range (*1)	5°C to 40°C, relative humidity 80% or less (at 35°C) with no condensation
Storage temperature/humidity range	0°C to 45°C, relative humidity 80% or less (at 35°C) with no condensation

*1 Operating temperature/humidity range of products for North America : 5 to 40 °C, relative humidity 80% or less (at 31°C) with no condensation

System Diagram

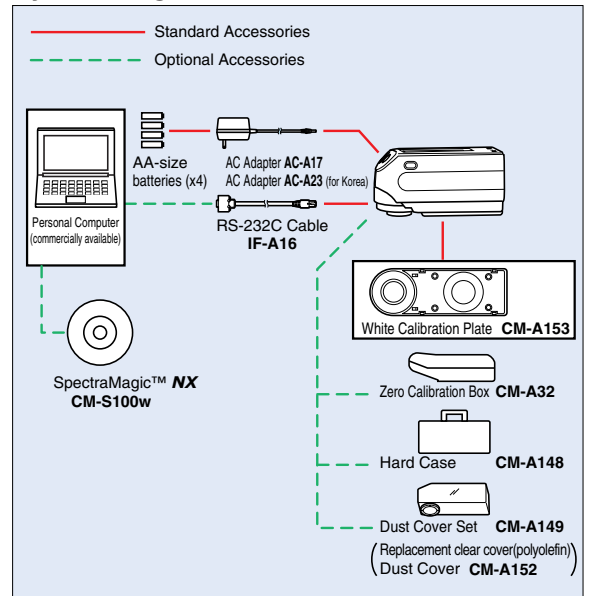

• Specifications are subject to change without notice.



Certificate No : YKA 0937154
Registration Date : March 3, 1995



Certificate No : JQA-E-80027
Registration Date : March 12, 1997

SAFETY PRECAUTIONS

For correct use and for your safety, be sure to read the instruction manual before using the instrument.



- Always connect the instrument to the specified power supply voltage. Improper connection may cause a fire or electric shock.
- Be sure to use the specified batteries. Using improper batteries may cause a fire or electric shock.

KONICA MINOLTA SENSING, INC.
 Konica Minolta Sensing Americas, Inc
 Konica Minolta Sensing Europe B.V.

Osaka, Japan
 New Jersey, U.S.A.
 European Headquarter /BENELUX
 German Office (International)
 German Office (Germany)
 French Office
 UK Office
 Italian Office
 Swiss Office
 Nordic Office
 Austrian Office
 Polish Office

Phone : 888-473-2656(in USA), 201-236-4300(outside USA)
 Nieuwegein, Netherland
 Langenhagen, Germany
 München, Germany
 Roissy CDG, France
 Milton Keynes, United Kingdom
 Milan, Italy
 Dietikon, Switzerland
 Västra Frölunda, Sweden
 Wien, Austria
 Warszawa, Poland
 Shanghai, China
 Beijing, China
 Guangzhou, China
 Singapore
 Seoul, Korea

Fax : 201-785-2480
 +31(0)30 248-1211
 +49(0)511 7404-807
 +49(0)89 630267-67
 +33(0)1 493-84771
 +44(0)1908 540-629
 +39(0)23 9011219
 +41(0)43 322-9809
 +46(0)31 474945
 +43(0)1 87882-431
 +48(0)22 56033-01
 +86-021-5489 0202
 +86-010-8522 1551
 +86-020-3826 4220
 +65 6563-5533
 +02-523-9726

Konica Minolta (CHINA) Investment Ltd.
 SE Sales Division
 SE Beijing Office
 SE Guangzhou Office

Konica Minolta Sensing Singapore Pte Ltd.
KONICA MINOLTA SENSING, INC. Seoul Office

Addresses and telephone/fax numbers are subject to change without notice. For the latest contact information, please refer to the KONICA MINOLTA SENSING Worldwide Offices web page (link below).

<http://konicaminolta.com/about/se/contact.html>